

YF325 Industrial Router User Manual	Document Version	Security Classification
	V1.0.1	
	Product Name: YF325	Total: 96 pages

YF325 Series Router User Manual

The user manual is suitable for the following model:

YF325Series 2G/3G/4G Cellular Router 1x WAN/LAN, 1 x LAN, 1 x RS232/RS485

Model No.	Description
YF325-L	4G LTE Router, Single SIM
YF325-L-SIM2	4G LTE Router, Dual SIM



Xiamen Yifan Communication Technology Co., Ltd.

Add: 14th Floor, No.370, Chengyi Street, Jimei,

Xiamen, China Zip Code: 361000

Tel: +86 592-6101492

Fax: +86 592-5222813

<http://www.yifanwireless.com>

Files Revised Record

Date	Version	Remark	Author
2018-7-21	V1.0.0	Initial Version	Harven
2024-8-30	V1.0.1	Update SIM card operation	Leon

Product Picture



Note: There may be differences between models of accessories and interfaces, actual products shall prevail.

Contents

Chapter 1 Brief Introduction of Product	6
1.1 General	6
1.2 Working Principle Diagram	7
1.3 Specification	7
Chapter 2 Installation Introduction	10
2.1 Overview	10
2.2 Encasement List	10
2.3 Installation and Cable Connection	10
2.4 About Power	14
2.5 LED Indicator	15
2.6 Reset Button	15
Chapter 3 Configuration and Management	16
3.1 Configuration Connection	16
3.2 Access the Configuration Page	16
3.2.1 PC IP Address Setting (Two Methods)	16
3.2.2 Login to Configuration Page	18
3.3 Configuration and Management	19
3.3.1 Setting	19
3.3.1.1 Basic Setting	19
3.3.1.2 Dynamic DNS	26
3.3.1.3 Clone MAC Address	27
3.3.1.4 Advanced Router	28
3.3.1.5 VLANs	29
3.3.1.6 Networking	30
3.3.2 Wireless	33
3.3.2.1 Basic Settings	33
3.3.2.2 Wireless Security	36
3.3.3 Services	39
3.3.3.1 Services	39
3.3.4 VPN	43
3.3.4.1 PPTP	43
3.3.4.2 L2TP	44
3.3.4.3 OPENVPN	46
3.3.4.4 IPSEC	51
3.3.4.5 GRE	55
3.3.5 Security	56
3.3.5.1 Firewall	56
3.3.6 Access Restrictions	60
3.3.6.1 WAN Access	60
3.3.6.2 URL Filter	63
3.3.6.3 Packet Filter	64

3.3.7	NAT	65
3.3.7.1	Port Forwarding.....	65
3.3.7.2	Port Range Forward.....	66
3.3.7.3	DMZ.....	67
3.3.8	QoS Setting	68
3.3.8.1	Basic.....	68
3.3.8.2	Classify.....	69
3.3.9	Applications	69
3.3.9.1	Serial Application.....	69
3.3.10	Administration	71
3.3.10.1	Management	71
3.3.10.2	Keep Alive	74
3.3.10.3	Commands.....	75
3.3.10.4	Factory Defaults	76
3.3.10.5	Firmware Upgrade	76
3.3.10.6	Backup	77
3.3.11	Status.....	78
3.3.11.1	Router.....	78
3.3.11.2	WAN	81
3.3.11.3	LAN.....	84
3.3.11.4	Wireless.....	87
3.3.11.5	Bandwidth.....	89
3.3.11.6	System-Info	90
Appendix	94

Chapter 1 Brief Introduction of Product

1.1 General

YF325 Industrial Router is an IoT wireless communication router. It is using public cellular network GPRS/CDMA/WCDMA/EVDO/LTE to provide long distance, wireless and large data transmission function for users.

The product uses the high-performance industrial-grade CPU and wireless module, with the embedded real-time operating system as the software support platform. It provides a RS232 (or RS485), 1 ethernet LAN, 1 ethernet WAN and a WIFI, can be connected to the serial device, ethernet devices and WIFI devices at the same time, achieve data pass-through function.

The product has been widely used in the M2M industry of the IoT industrial chain, such as smart grid, intelligent transportation, smart home, finance, mobile POS terminals, supply chain automation, industrial automation, intelligent building, fire protection, public safety, environmental protection, meteorology, digital medical, telemetry, agriculture, forestry, water, coal, petrochemical and other related fields.

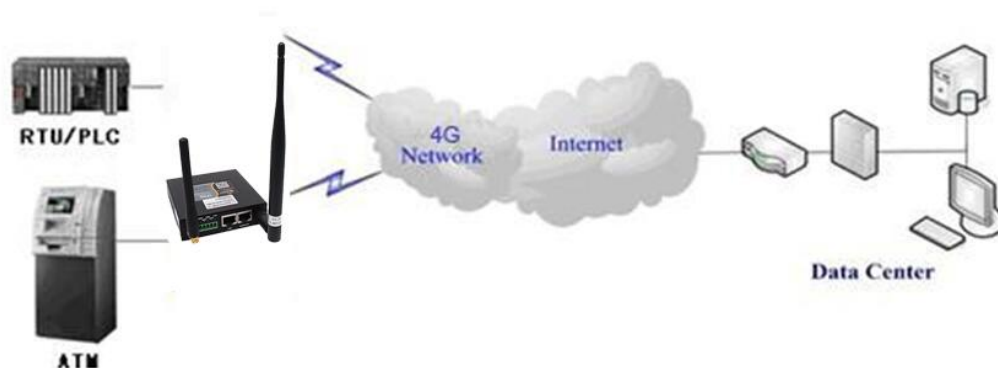

1.2 Working Principle Diagram

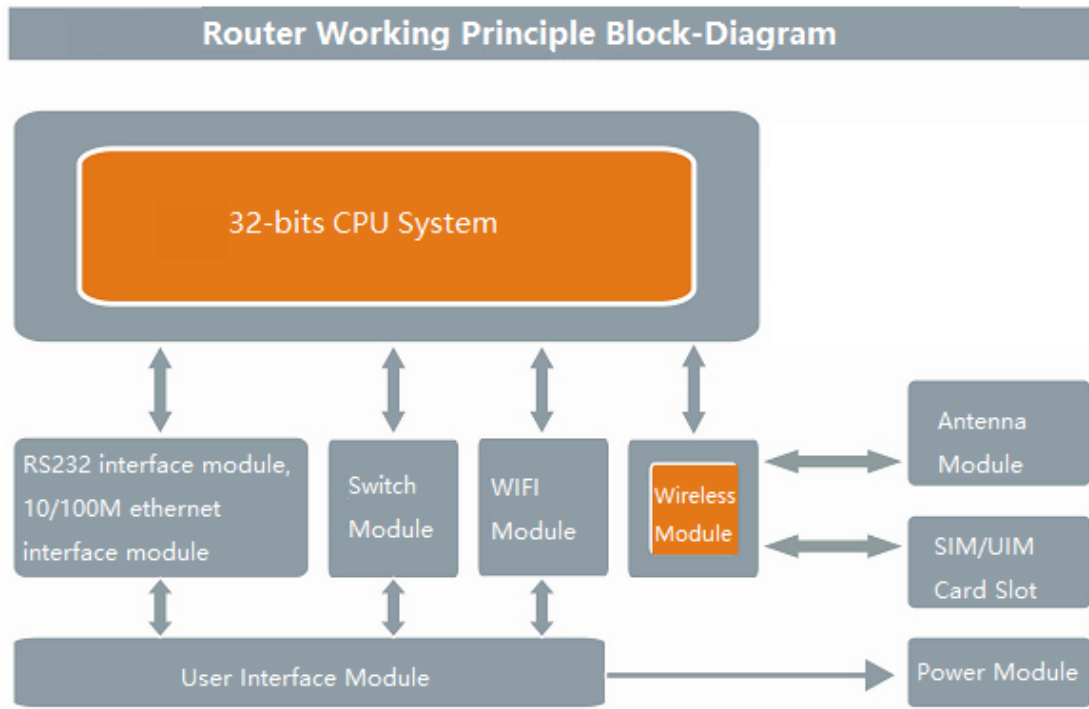

1.3 Specification

Cellular Specification

Item	Content
YF325-L LTE WIFI Industrial Router	
Standard and Band	LTE FDD: B1/B2/B3/B4/B5/B7/B8/B28 (2100/1900/1800/850/2600/900/800MHz) FDD: B1/B3/B5/B7/B8/B20 (Optional) LTE TDD: B40, B38/B39/B40/B41(Optional) HSPA+/HSUPA/HSDPA/WCDMA/UMTS 2100/1900/900/850MHz EDGE/GPRS/GSM 1900/1800/900/850MHz
Bandwidth	FDD-LTE: Downstream rate 150Mbps, uplink rate 50Mbps TD-LTE: Downstream rate 130Mbps, uplink rate 35Mbps TD-HSPA+: Downstream rate 4.2Mbps, uplink rate 2.2Mbps DC-HSPA+: Downstream rate 42Mbps, uplink rate 5.76 Mbps HSPA+: Downstream rate 21Mbps, uplink rate 5.76 Mbps HSDPA: Downstream rate 7.2Mbps, HSUPA: uplink rate 5.76Mbps UMTS: 384Kbps
Transmit Power	<23dBm
Sensitivity	<-97dBm

WIFI Specification

Item	Content
Standard and Band	IEEE802.11b/g/n
Bandwidth	IEEE802.11b/g: 54Mbps (Maximum) IEEE802.11n: 144Mbps (Maximum)
Security	Support WEP, WPA, WPA2 encrypt methods, optional WPS function
Transmit Power	15±2dBm
Sensitivity	<-72dBm@54Mbps

Hardware System

Item	Content
CPU	Industrial-grade CPU
FLASH	16MB
DDR2	128MB

Interface

Item	Content
WAN Interface	one 10/100M RJ45 ethernet port, adaptive MDI/MDIX, built-in 15KV ESD
LAN Interface	one 10/100M RJ45 ethernet port, adaptive MDI/MDIX, built-in 15KV ESD
Serial	one RS232/485 serial interface with built-in 15KV ESD Data bits:5, 6, 7, 8 bits Stop bits:1, 1.5 (optional), 2 bits Error detection: none, even parity, odd parity, SPACE (optional) and MARK (optional) Serial Port Rate: 2400~115200bits/s
LED Indicators	"PWR", "Online", "LAN", "WAN/LAN", "WIFI"
Antenna Interface	Cellular: Standard SMA female antenna interface, characteristic impedance: 50 Ω WIFI: Standard SMA male antenna interface, characteristic impedance: 50 Ω
SIM/UIM Slot	Standard SIM card slot, support 1.8V/3V SIM/UIM card, built-in 15KV ESD
Power Interface	Standard 3.5mm terminal block interface, with built-in phase-reversal and over-voltage protection
Reset Button	Can reset router's configuration to default factory setting by this button



Note: There may be differences between models of accessories and interfaces, actual products shall prevail.

Power

Item	Content
Input Voltage	DC 12V/1.5A
Accepted Voltage Range	DC 5~36V

Power Consumption

Work Mode	Consumption
Standby	95~135mA@12VDC
Communicating	165~220mA@12VDC

Physical Properties

Item	Content
Casing	Metal casing, IP30 protection level, suitable for most industrial control applications.
Dimensions	93x89x24mm (excluding antennas and mountings)
Weight	250g

Others

Item	Content
Operating Temperature	-35~+75°C
Storage Temperature	-40~+85°C
Relative Humidity	95% (non-condensing)

Chapter 2 Installation Introduction

2.1 Overview

Router must be installed correctly before they achieve the designed features, the device must be installed by the guidance of a qualified engineer who recognized by the Company.

- *Warning:*
Please do not install the device while powered on.

2.2 Encasement List

To transport safety, you will need a reasonable packaging. After you unpack the device, please keep the packaging materials for future transport needs.

It includes the following components:

- ✧ 1 Host Device (Packaging according to the order)
- ✧ 1 User's guide CD
- ✧ Wireless cellular antenna (SMA male head)
- ✧ 1 WIFI antenna (SMA female head) (Optional)
- ✧ 1 Power cable
- ✧ Product certification
- ✧ Warranty Card

2.3 Installation and Cable Connection

Dimension (unit: mm)

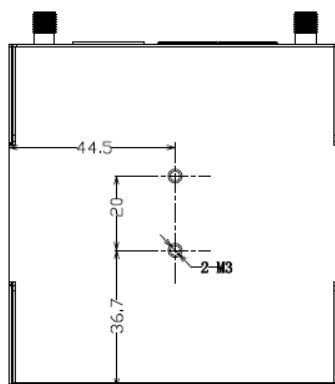

DIN Rail installing position

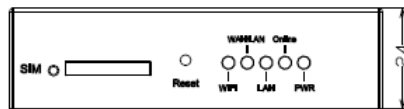
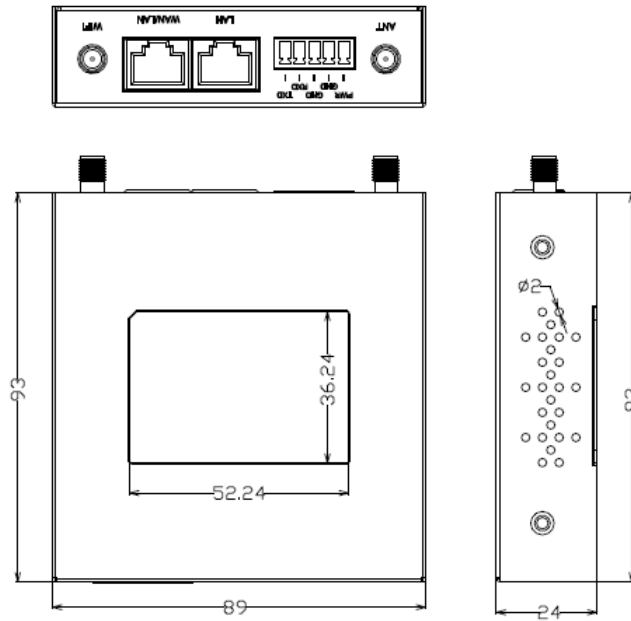

DIN Rail Style Router Dimension

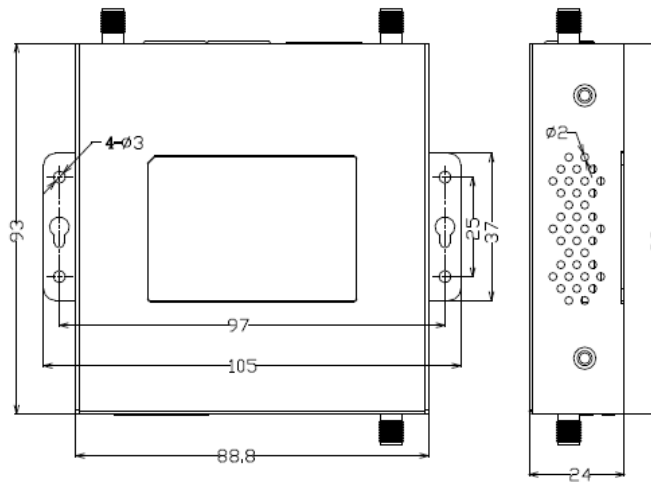

Wall Mount Style Router Dimension

Note: This router device use DIN Rail to install, use M3 screw to secure the clip, the depth is 3-4mm.

Antenna Installation:

Wireless WAN antenna interface is a standard SMA female antenna interface (marked as 'ANT'), put the cellular antenna on the interface, make sure it has been tightening to avoid affect the signal quality.

Wireless LAN antenna interface is a standard SMA male antenna interface (marked as 'WIFI'), put the WIFI antenna on the interface, make sure it has been tightening to avoid affect the signal quality.

Note: The wireless cellular antenna cannot be mixed up with WIFI antenna, otherwise the device cannot work properly.

SIM/UIM Card Installation:

Gently press the eject button (the round dot on the left side of the card slot) with a pen or pin, SIM/UIM slot will pop up. When installing SIM/UIM card, put the card into the card slot and make sure the metal chip surface is facing outside, then insert the card slot in to the device.

(Following is an example for dual sim card version)

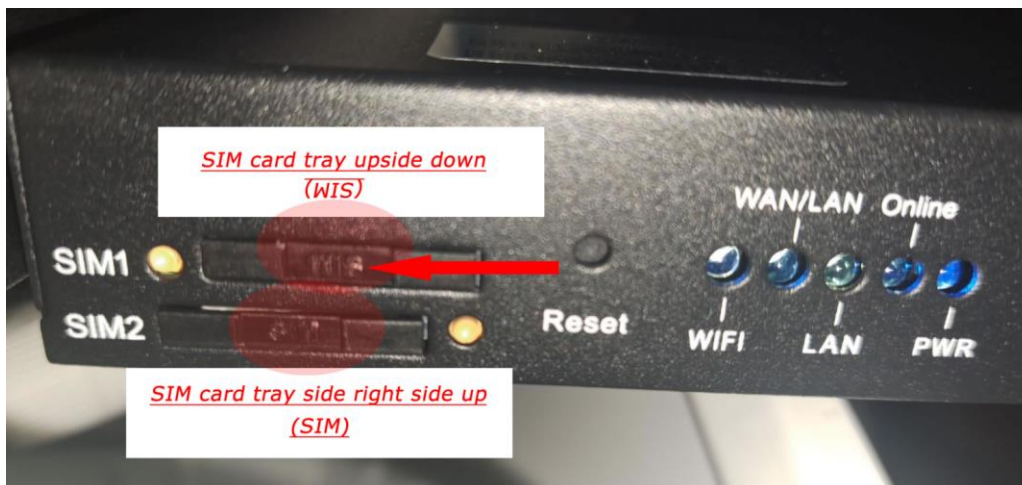

Press the eject button and then insert the sim card.

Ethernet Cable Connection:

Connect one side of the ethernet cable to the LAN port on the router, the other side to the user device's ethernet port. The cable's definition is as following:

RJ45-1	RJ45-2	Color
1	1	White/Orange
2	2	Orange
3	3	White/Green
4	4	Blue
5	5	White/Blue
6	6	Green
7	7	White/Brown
8	8	Brown



3.5mm Terminal Block Interface Definition:

The 5-pin terminal block includes POWER and RS232(RS485) function. The definition is as following:

No.	Definition	Description	Extension
1	PWR	Device power supply positive	
2	GND	Device power supply negative	
3	GND	RS232 GND	
4	RXD	RS232 receiving	RS485 A

5	TXD	RS232 sending	RS485 B
---	-----	---------------	---------

Serial port connection: (When needed)

Connect the serial cable to the router with the terminal block interface, the DB9 side connect to the user's device. The cable's definition is as following:

Terminal block	Color	Definition	DB9F	Description	On router's end
1	Brown	TXD	2	Sending	Sending
2	Blue	RXD	3	Receiving	Receiving
3	Black	GND	5	GND	



2.4 About Power

The YF325 router is usually used in complex external environments. To fit the environment and improve the system stability, the router uses advanced power technology. User can use standard 12VDC/1.5A power adapter which come with the device, or use any DC 5-36V power to provide power supply directly for the device. When user use extra power supply, it must be stable (the ripple should less than 300mV, and the instantaneous voltage should not exceed 36V), and ensure the power is greater than 8W.

We recommend using the standard 12VDC/1.5A power adapter which come with the device.

2.5 LED Indicator

Router has the following LED indicators: 'PWR', 'Online', 'LAN', 'WAN/LAN', 'WIFI'.

Indicator	Status	Description
PWR	On	Power supply is fine
	Off	No power
Online	On	Device is online
	Off	Device is offline
LAN	Off	No connection on LAN
	On/Flashing	Detected LAN connection/Communicating
WAN/LAN	Off	WAN/LAN no connection
	On/Flashing	WAN/LAN already connected/Communicating
WIFI	Off	WIFI is not on
	On	WIFI is on

2.6 Reset Button

Router has a reset button, marked as 'Reset'. This button is used for restoring the device back to factory setting. Use a pen or pin and push the reset button for 15 seconds and release, the router will reset all the setting. After 10 seconds, the router will automatically reboot (the 'System' LED indicator will go off for 10 seconds and back to normal status).

Chapter 3 Configuration and Management

3.1 Configuration Connection

The router should be connected to the PC with the supplied ethernet cable or WIFI connection before doing the configuration for the router. When using the wired connection method, insert the ethernet cable into any LAN port of the router, insert the other side of the cable into the ethernet port on your PC. When using the WIFI connection method, the default SSID is 'SSID', no password.

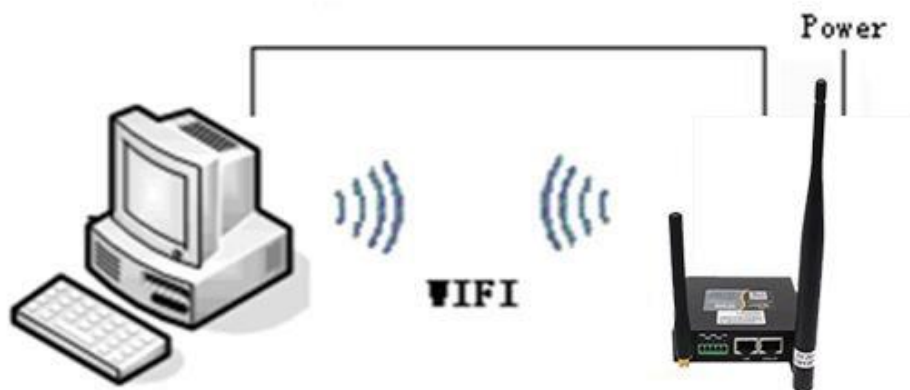

3.2 Access the Configuration Page

3.2.1 PC IP Address Setting (Two Methods)

First method: Automatically obtain IP address

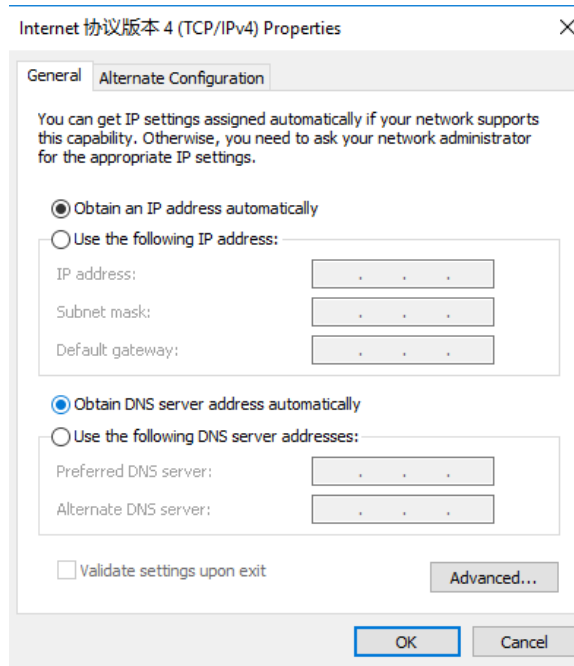

Second method: static IP

Set the PC IP address as 192.168.1.9 (or other IP address in the same 192.168.1 segment), subnet mask is 255.255.255.0, default gateway is 192.168.1.1. DNS can be set to any DNS server available in that area.

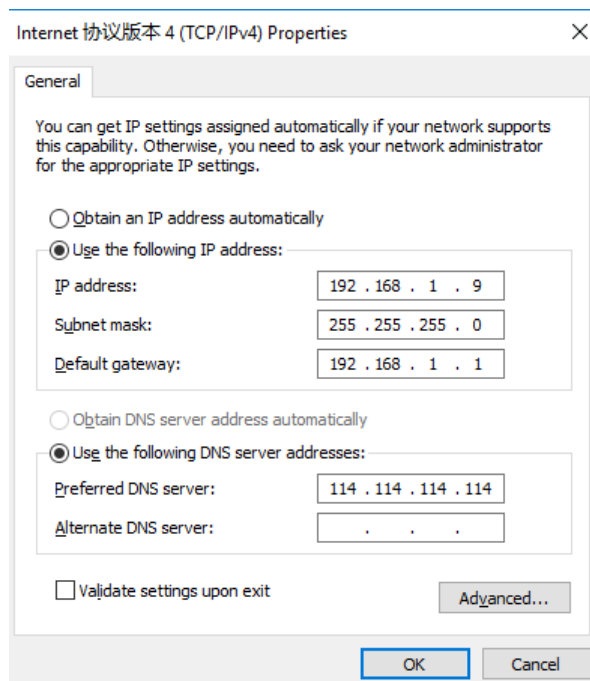

3.2.2 Login to Configuration Page

This chapter will introduce the main functions for all the setting pages. Users can use web browser on the connected PC to access the router’s configuration portal. There are 11 main pages: Setup, Wireless, Services, VPN, Security, Access Restrictions, NAT, QoS Setting, Applications, Administration, Status.

To access the web-based configuration tool, open IE or other browser and type in the default router IP address 192.168.1.1, then press enter. When access to the web configuration page first time, the following page will show up, ask user whether to change the default username and password or not. Click ‘Change Password’ to proceed to the next step.

Router Management

Your Router is currently not protected and uses an unsafe default username and password combination, please change it using the following dialog!

Router Password

Router Username:

Router Password:

Re-enter to confirm:

You will see a page which similar as the following page after clicking the button.

Firmware: v2.1.0 (Sep 8 2021 08:54:42) std
 Time: 11:12:47 up 1:04; load averages: 0.01, 0.04, 0.04
 WAN IP: 10.77.212.64, BKUP WAN IP: 0.0.0.0

Wireless Mobile Router
2G/3G/4G/5G

Menu

- [Setup](#)
- [Wireless](#)
- [Services](#)
- [VPN](#)
- [Security](#)
- [NAT](#)
- [Access Restrictions](#)
- [QoS Setting](#)
- [Applications](#)
- [Administration](#)
- [Status](#)

System Information

Router	
Router Name	Router
Router Model	Router
LAN MAC	54:D0:B4:26:05:84
WAN MAC	54:D0:B4:26:05:85
Wireless MAC	00:11:22:33:44:57
WAN IP	10.77.212.64
BKUP WAN IP	0.0.0.0
LAN IP	192.168.1.1

Services	
DHCP Server	Enabled
radauth	Disabled
USB Support	Enabled

Memory	
Total Available	494.3 MB / 512.0 MB
Free	381.7 MB / 494.3 MB
Used	112.6 MB / 494.3 MB
Buffers	402.4 MB / 112.6 MB
Cached	6.7 MB / 112.6 MB
Active	0.0 MB / 112.6 MB
Inactive	13.3 MB / 112.6 MB

Wireless	
Radio	Radio is On
Mode	AP
Network	Mixed
SSID	ssid
Channel	0 (2.437 GHz)
TX Power	20 dBm
Rate	96 Mb/s

Wireless Packet Info	
Received (RX)	9482 OK, no error
Transmitted (TX)	12133 OK, no error

User may need to type in username and password in order to access any items of the menu.

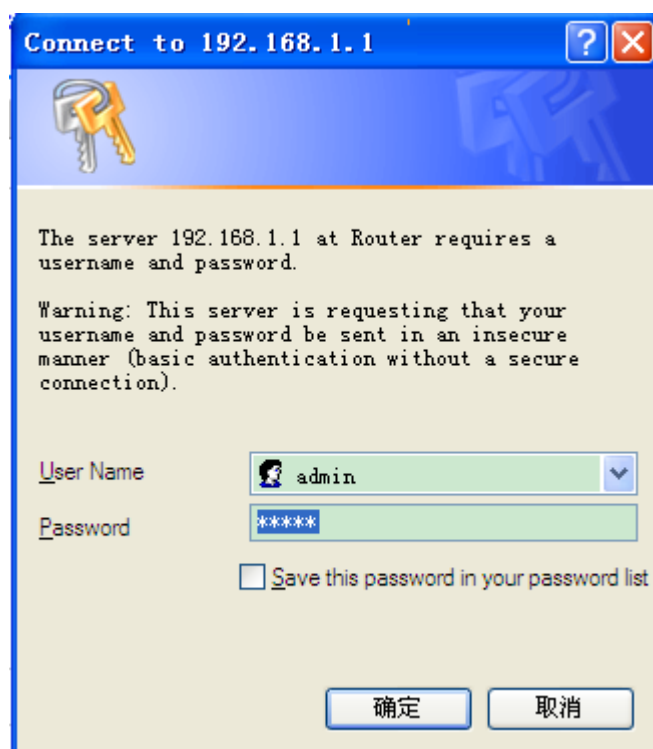

Type in the correct username and password, then click Submit. the default username is admin, password is admin. You can change it under the Management section.

3.3 Configuration and Management

3.3.1 Setting

Click 'Setup', the first page is for basic settings. On this page, you can change some basic settings, click 'Saved' button to save the setting but it won't take effect, click the 'Apply Settings' button to let the changes take effect, or click 'Cancel Changes' to undo the changes.

3.3.1.1 Basic Setting

'WAN Connection Type' is the section to configure how to let the router connect to internet. You can get the detail information from your Internet Services Provider (IPS).

WAN Connection Type

Pick the connection type from the dropdown list. There are 7 connection types: disabled, static IP, dynamic IP, automatic configuration - DHCP, PPPoE, 3G/UMTS/4G/LTE, DHCP-4G/5G.

Type 1: Disable

Connection Type

Disable WAN port connection

Type 2: Static IP

This connection type usually used for dedicated line such as business or enterprise fiber. The ISP will provide you with the detail parameters such as IP address, subnet mask, gateway and DNS. You will need to use these parameters to set up the router.

Connection Type	<input type="text" value="Static IP"/>			
WAN IP Address	<input type="text" value="0"/>	<input type="text" value="0"/>	<input type="text" value="0"/>	<input type="text" value="0"/>
Subnet Mask	<input type="text" value="0"/>	<input type="text" value="0"/>	<input type="text" value="0"/>	<input type="text" value="0"/>
Gateway	<input type="text" value="0"/>	<input type="text" value="0"/>	<input type="text" value="0"/>	<input type="text" value="0"/>
Static DNS 1	<input type="text" value="0"/>	<input type="text" value="0"/>	<input type="text" value="0"/>	<input type="text" value="0"/>
Static DNS 2	<input type="text" value="0"/>	<input type="text" value="0"/>	<input type="text" value="0"/>	<input type="text" value="0"/>
Static DNS 3	<input type="text" value="0"/>	<input type="text" value="0"/>	<input type="text" value="0"/>	<input type="text" value="0"/>
Keep Online Detection	<input type="text" value="Ping"/>			
Detection Interval	<input type="text" value="120"/>	Sec.		
Primary Detection Server IP	<input type="text" value="114"/>	<input type="text" value="114"/>	<input type="text" value="114"/>	<input type="text" value="114"/>
Backup Detection Server IP	<input type="text" value="208"/>	<input type="text" value="67"/>	<input type="text" value="220"/>	<input type="text" value="220"/>
STP	<input type="radio"/> Enable <input checked="" type="radio"/> Disable			

WAN IP Address: the IP address which allocated by user or provided by the ISP

Subnet Mask: the subnet mask which allocated by user or provided by the ISP

Gateway: the gateway which allocated by user or provided by the ISP

Static DNS (1-3): the DNS which allocated by user or provided by the ISP

Type 3: Automatic Configuration - DHCP

The default WAN connection type. Some cable provider and residential internet service use this connection type.

Connection Type

The IP address of the WAN port obtained by DHCP

Type 4: PPPoE

China Telecom and China Netcom ADSL services usually use this type of connection, other ISP may also use this type. PPPoE connection needs ISP to provide you the username, password and the service name, this information need to put in the related setting fields of

the router.

Connection Type

 User Name

 Password Unmask

User Name: the user name for login to the Internet

Password: the password for login to the Internet

Type 5: 3G/UMTS/4G/LTE

3G/UMTS/4G/LTE

Connection Type

 User Name

 Password Unmask

 Dial String

 APN

 PIN Unmask

User Name: the user name for login to the Internet

Password: the password for login to the Internet

Dial String: the number to call the service provider

APN: access point name

PIN: the PIN of the SIM card

Connection Type

Connection type

Connection Type: including auto, force 3G, force 2G and so on, if using 4G module, it will have related 4G options, based on the user's requirement and different cellular module to select.

Type 6: DHCP-4G/5G

Main WAN Connection Type

 Connection Type

WAN IP obtained by DHCP-4G/5G

Keep Online

Keep Online Detection	<input type="text" value="Ping"/>
Detection Interval	<input type="text" value="120"/> Sec.
Primary Detection Server IP	<input type="text" value="114"/> . <input type="text" value="114"/> . <input type="text" value="114"/> . <input type="text" value="114"/>
Backup Detection Server IP	<input type="text" value="208"/> . <input type="text" value="67"/> . <input type="text" value="220"/> . <input type="text" value="220"/>

This function is used to detect whether the Internet connection is active. If this setting is on, the router will automatic check the internet connection. When it detects invalid connection, or the connection is disconnected, the system will automatically reconnect and rebuild a valid internet connection. If the network quality is poor or it is under a private network, we recommend using the 'Router' mode.

Keep Online Methods:

None: do not set this function

Ping: Send ping packet to detect the connection, when choose this method, users should also configure "Detection Interval", "Primary Detection Server IP" and "Backup Detection Server IP" items.

Route: Detect connection with route method, when choose this method, users should also configure "Detection Interval", "Primary Detection Server IP" and "Backup Detection Server IP" items.

PPP: Detect connection with PPP method, when choose this method, users should also configure "Detection Interval" item.

Detection Interval: time interval between two detections, unit is second

Primary Detection Server IP: the server used to response the Router's detection packet. This item is only valid for method "Ping" and "Route".

Backup Detection Server IP: the server used to response the Router's detection packet.

Force reconnect	<input checked="" type="radio"/> Enable <input type="radio"/> Disable
Time	<input type="text" value="00"/> : <input type="text" value="00"/>

Force reconnect: this option schedules the PPPOE or 3G reconnection by killing the pppd daemon and restart it.

Time: needed time to reconnect

STP

STP Enable Disable

STP (Spaning Tree Protocol) can be applied to loop network. Through certain algorithm achieves path redundancy, and loop network cuts to tree-based network without loop in the meantime, thus to avoid the hyperplasia and infinite circulation of a message in the loop network

Optional Configuration

Router Name	FF
Host Name	
Domain Name	
MTU	Auto <input type="button" value="1500"/>

Router Name: set Router name

Host Name: ISP provides

Domain Name: ISP provides

MTU: auto (1500) and manual (1200-1492 in PPPOE/PPTP/L2TP mode, 576-16320 in other modes)

Router Internal Network Settings

Router IP

Local IP Address	192	.	168	.	1	.	1
Subnet Mask	255	.	255	.	255	.	0
Gateway	0	.	0	.	0	.	0
Local DNS	0	.	0	.	0	.	0

Local IP Address: IP address of the Router

Subnet Mask: the subnet mask of the Router

Gateway: set internal gateway of the Router. If default, internal gateway is the address of the Router

Local DNS: DNS server is auto assigned by network operator server. Users enable to use their own DNS server or other stable DNS servers, if not, keep it default

Network Address Server Settings (DHCP)

These settings for the Router's Dynamic Host Configuration Protocol (DHCP) server functionality

configuration. The Router can serve as a network DHCP server. DHCP server automatically assigns an IP address for each computer in the network. If they choose to enable the Router's DHCP server option, users can set all the computers on the LAN to automatically obtain an IP address and DNS, and make sure no other DHCP server in the network.

Network Address Server Settings (DHCP)

DHCP Type	DHCP Server ▾
DHCP Server	<input checked="" type="radio"/> Enable <input type="radio"/> Disable
Start IP Address	192.168.1. 100
Maximum DHCP Users	50
Client Lease Time	1440 minutes
Static DNS 1	0 . 0 . 0 . 0
Static DNS 2	0 . 0 . 0 . 0
Static DNS 3	0 . 0 . 0 . 0
WINS	0 . 0 . 0 . 0
Use DNSMasq for DHCP	<input checked="" type="checkbox"/>
Use DNSMasq for DNS	<input checked="" type="checkbox"/>
DHCP-Authoritative	<input checked="" type="checkbox"/>

DHCP Type: DHCP Server and DHCP Forwarder

Enter DHCP Server if set DHCP Type to DHCP Forwarder as blow:

DHCP Type	DHCP Forwarder ▾
DHCP Server	0 . 0 . 0 . 0

DHCP Server: keep the default Enable to enable the Router's DHCP server option. If users

have already have a DHCP server on their network or users do not want a DHCP server, then select Disable

Start IP Address: enter a numerical value for the DHCP server to start with when issuing IP addresses. Do not start with 192.168.1.1 (the Router's own IP address).

Maximum DHCP Users: enter the maximum number of PCs that users want the DHCP server to assign IP addresses to. The absolute maximum is 253 if 192.168.1.2 is users' starting IP address.

Client Lease Time: the Client Lease Time is the amount of time a network user will be allowed connection to the Router with their current dynamic IP address. Enter the amount of time, in minutes, that the user will be "leased" this dynamic IP address.

Static DNS (1-3): the Domain Name System (DNS) is how the Internet translates domain or website names into Internet addresses or URLs. Users' ISP will provide them with at least one DNS Server IP address. If users wish to utilize another, enter that IP address in one of these fields. Users can enter up to three DNS Server IP addresses here. The Router will utilize them for quicker access to functioning DNS servers.

WINS: the Windows Internet Naming Service (WINS) manages each PC's interaction with the Internet. If users use a WINS server, enter that server's IP address here. Otherwise, leave it blank.

DNSMasq: users' domain name in the field of local search, increase the expansion of the host option, to adopt DNSMasq can assign IP addresses and DNS for the subnet, if select DNSMasq, dhcpd service is used for the subnet IP address and DNS.

Time Settings

Select time zone of your location. To use local time, leave the checkmark in the box next to Use local time.

NTP Client	<input checked="" type="radio"/> Enable <input type="radio"/> Disable
Time Zone	UTC+08:00 ▼
Summer Time (DST)	last Sun Mar - last Sun Oct ▼
Server IP/Name	<input type="text"/>

NTP Client: Get the system time from NTP server

Time Zone: Time zone options

Summer Time (DST): set it depends on users' location

Server IP/Name: IP address of NTP server, up to 32 characters. If blank, the system will find

a server by default

Adjust Time

Time

To adjust time by the system and refresh to get the time of the web, user can set to modify the time of the system. They can change to adjust time by manual to achieve adjust time by the system if the system fails to get NTP server

3.3.1.2 Dynamic DNS

If user's network has a permanently assigned IP address, users can register a domain name and have that name linked with their IP address by public Domain Name Servers (DNS). However, if their Internet account uses a dynamically assigned IP address, users will not know in advance what their IP address will be, and the address can change frequently. In this case, users can use a commercial dynamic DNS service, which allows them to register their domain to their IP address, and will forward traffic directed at their domain to their frequently-changing IP address.

DDNS Service: Router currently support DynDNS, freedns, Zoneedit, NO-IP, 3322, easyDNS, TZO, DynSIP and Custom based on the user.

DDNS

DDNS Service

User Name

Password Unmask

Host Name

Type

Wildcard

Do not use external ip check Yes No

User Name: users register in DDNS server, up to 64 characteristic

Password: password for the user name that users register in DDNS server, up to 32 characteristic

Host Name: users register in DDNS server, no limited for input characteristic for now

Page 26 of 95

Type: depends on the server

Wildcard: support wildcard or not, the default is OFF. ON means *.host.3322.org is equal to host.3322.org

Do not use external ip check: enable or disable the function of 'do not use external ip check'

Force Update Interval (Default: 10 Days, Range: 1 - 60)

Force Update Interval: unit is day, try forcing the update dynamic DNS to the server by setted days

Status

```

DDNS Status
Fri Nov 25 13:58:32 2011: INADYN: Started 'INADYN Advanced version 1.96-ADV' - dynamic DNS updater.
Fri Nov 25 13:58:32 2011: INADYN: IP read from cache file is '192.168.8.222'. No update required.
Fri Nov 25 13:58:32 2011: I:INADYN: IP address for alias 'testsixin.3322.org' needs update to '192.168.8.38'
Fri Nov 25 13:58:33 2011: I:INADYN: Alias 'testsixin.3322.org' to IP '192.168.8.38' updated successfully.
    
```

DDNS Status shows connection log information

3.3.1.3 Clone MAC Address

Some ISP need the users to register their MAC address. The users can clone the Router MAC address to their MAC address registered in ISP if they do not want to re-register their MAC address

Enable Disable

Clone LAN(VLAN) MAC : : : : :

Clone WAN MAC : : : : :

[Get Current PC MAC Address](#)

Clone LAN(Wireless) MAC : : : : :

Clone MAC address can clone three parts: Clone LAN MAC, Clone WAN MAC, Clone Wireless MAC.

Noted that one MAC address is 48 characteristic, can not be set to the multicast address, the first byte must be even. And MAC address value of network bridge br0 is determined by the smaller value of wireless MAC address and LAN port MAC address.

3.3.1.4 Advanced Router

Operating Mode: Gateway and Router



Operating Mode

Gateway

If the Router is hosting users' Internet connection, select Gateway mode. If another Router exists on their network, select Router mode.

Dynamic Routing

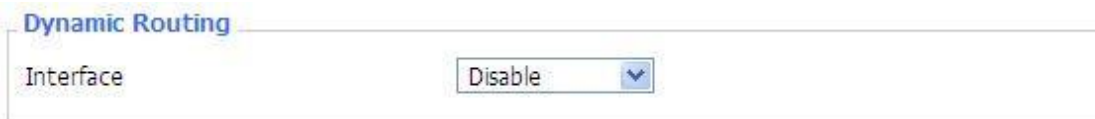

Dynamic Routing

Interface

Disable

Dynamic Routing enables the Router to automatically adjust to physical changes in the network's layout and exchange routing tables with other Routers. The Router determines the network packets' route based on the fewest number of hops between the source and destination.

To enable the Dynamic Routing feature for the WAN side, select WAN. To enable this feature for the LAN and wireless side, select LAN&WLAN. To enable the feature for both the WAN and LAN, select Both. To disable the Dynamic Routing feature for all data transmissions, keep the default setting, Disable.

Note: Dynamic Routing is not available in Gateway mode

Static Routing

Static Routing

Select set number: 1 ()

Route Name:

Metric:

Destination LAN NET: ...

Subnet Mask: ...

Gateway: ...

Interface: LAN & WLAN

Select set number: 1-50

Route Name: defined routing name by users, up to 25 characters

Metric: 0-9999

Destination LAN NET: the Destination IP Address is the address of the network or host to which users want to assign a static route

Subnet Mask: the Subnet Mask determines which portion of an IP address is the network portion, and which portion is the host portion

Gateway: IP address of the gateway device that allows for contact between the Router and the network or host.

Interface: indicate users whether the Destination IP Address is on the LAN & WLAN (internal wired and wireless networks), the WAN (Internet), or Loopback (a dummy network in which one PC acts like a network, necessary for certain software programs) **Show**

Routing Table

Routing Table Entry List			
Destination LAN NET	Subnet Mask	Gateway	Interface
192.168.1.1	255.255.255.255	0.0.0.0	WAN
192.168.1.0	255.255.255.0	0.0.0.0	LAN & WLAN
192.168.1.0	255.255.255.0	0.0.0.0	WAN
169.254.0.0	255.255.0.0	0.0.0.0	WAN
0.0.0.0	0.0.0.0	192.168.1.1	LAN & WLAN

3.3.1.5 VLANs

VLAN

VLAN	Port					Assigned To Bridge
	W	1	2	3	4	
1	<input type="checkbox"/>	<input checked="" type="checkbox"/>	<input checked="" type="checkbox"/>	<input checked="" type="checkbox"/>	<input checked="" type="checkbox"/>	LAN ▾
2	<input checked="" type="checkbox"/>	<input type="checkbox"/>	<input type="checkbox"/>	<input type="checkbox"/>	<input type="checkbox"/>	None ▾
3	<input type="checkbox"/>	<input type="checkbox"/>	<input type="checkbox"/>	<input type="checkbox"/>	<input type="checkbox"/>	None ▾
4	<input type="checkbox"/>	<input type="checkbox"/>	<input type="checkbox"/>	<input type="checkbox"/>	<input type="checkbox"/>	None ▾
5	<input type="checkbox"/>	<input type="checkbox"/>	<input type="checkbox"/>	<input type="checkbox"/>	<input type="checkbox"/>	None ▾
6	<input type="checkbox"/>	<input type="checkbox"/>	<input type="checkbox"/>	<input type="checkbox"/>	<input type="checkbox"/>	None ▾
7	<input type="checkbox"/>	<input type="checkbox"/>	<input type="checkbox"/>	<input type="checkbox"/>	<input type="checkbox"/>	None ▾
8	<input type="checkbox"/>	<input type="checkbox"/>	<input type="checkbox"/>	<input type="checkbox"/>	<input type="checkbox"/>	None ▾
9	<input type="checkbox"/>	<input type="checkbox"/>	<input type="checkbox"/>	<input type="checkbox"/>	<input type="checkbox"/>	None ▾
10	<input type="checkbox"/>	<input type="checkbox"/>	<input type="checkbox"/>	<input type="checkbox"/>	<input type="checkbox"/>	None ▾
11	<input type="checkbox"/>	<input type="checkbox"/>	<input type="checkbox"/>	<input type="checkbox"/>	<input type="checkbox"/>	None ▾
12	<input type="checkbox"/>	<input type="checkbox"/>	<input type="checkbox"/>	<input type="checkbox"/>	<input type="checkbox"/>	None ▾
13	<input type="checkbox"/>	<input type="checkbox"/>	<input type="checkbox"/>	<input type="checkbox"/>	<input type="checkbox"/>	None ▾
14	<input type="checkbox"/>	<input type="checkbox"/>	<input type="checkbox"/>	<input type="checkbox"/>	<input type="checkbox"/>	None ▾
15	<input type="checkbox"/>	<input type="checkbox"/>	<input type="checkbox"/>	<input type="checkbox"/>	<input type="checkbox"/>	None ▾

VLANs allow user to divide different VLAN port as they need, the system support VLAN1 to VLAN15, total is 15 VLAN port. LAN port and WAN port cannot be set to the same VLAN.

3.3.1.6 Networking

Create Bridge

Bridge 0 STP Prio MTU

Assign to Bridge

Current Bridging Table

Bridge Name	STP enabled	Interfaces
br0	no	vlan1

Bridging-Create Bridge: creates a new empty network bridge for later use. STP means Spanning Tree Protocol and with PRIO users are able to set the bridge priority order. The lowest number has the highest priority.

Bridging - Assign to Bridge: allows users to assign any valid interface to a network bridge. Consider setting the Wireless Interface options to Bridged if they want to assign any Wireless

Interface here. Any system specific bridge setting can be overridden here in this field.

Current Bridging Table: shows current bridging table

Create steps as below:

Click 'Add' to create a new bridge, configuration is as below:

Create Bridge

Bridge 0	br0	STP	Off	Prio	32768	MTU	1500	
Bridge 1	br1	STP	On	Prio	32768	MTU	1500	Delete

Add

Create bridge option: the first br0 means bridge name. STP means to on/off spanning tree protocol. Prio means priority level of STP, the smaller the number, the higher the level. MTU means maximum transfer unit, default is 1500, delete if it is not need. And then click 'Save' or 'Add'. Bride properties is as below:

Create Bridge

Bridge 0	br0	STP	Off	Prio	32768	MTU	1500	Delete
Bridge 1	br1	STP	On	Prio	32768	MTU	1500	Delete
IP Address	0 . 0 . 0 . 0							
Subnet Mask	0 . 0 . 0 . 0							

Add

Enter relewant bridge IP address and subnet mask, click 'Add' to create a bridge.

Note: Only create a bride can apply it.

Assign to Bridge

Assignment 0	none	Interface	ra0	Prio	63	Delete
--------------	------	-----------	-----	------	----	--------

Add

Assign to Bridge option: to assign different ports to created bridge. For example: assign port (wireless port) is ra0 in br1 bridge as below:

Prio means priority level: work if multiple ports are within the same bridge. The smaller the number, the higher the level. Click 'Add' to take it effect.

Note: corresponding interface of WAN ports interface should not be binding, this bridge function is basically used for LAN port, and should not be binding with WAN port

If bind success, bridge binding list in the list of current bridging table is as below:

Current Bridging Table

Bridge Name	STP enabled	Interfaces
br0	no	vlan0
br1	yes	ra0

To make br1 bridge has the same function with DHCP assigned address, users need to set multiple DHCP function, see the introduction of multi-channel DHCPD:

Port Setup

Network Configuration eth2	<input type="radio"/> Unbridged	<input checked="" type="radio"/> Default
Network Configuration vlan0	<input type="radio"/> Unbridged	<input checked="" type="radio"/> Default
Network Configuration ra0	<input type="radio"/> Unbridged	<input checked="" type="radio"/> Default
Network Configuration apcli0	<input type="radio"/> Unbridged	<input checked="" type="radio"/> Default
Network Configuration wds0	<input type="radio"/> Unbridged	<input checked="" type="radio"/> Default
Network Configuration wds1	<input type="radio"/> Unbridged	<input checked="" type="radio"/> Default
Network Configuration wds2	<input type="radio"/> Unbridged	<input checked="" type="radio"/> Default
Network Configuration wds3	<input type="radio"/> Unbridged	<input checked="" type="radio"/> Default
Network Configuration br0	<input type="radio"/> Unbridged	<input checked="" type="radio"/> Default

Port Setup: Set the port property, the default is not set

Network Configuration ra0	<input checked="" type="radio"/> Unbridged	<input type="radio"/> Default
MTU	<input type="text" value="1500"/>	
Multicast forwarding	<input type="radio"/> Enable	<input checked="" type="radio"/> Disable
Masquerade / NAT	<input checked="" type="radio"/> Enable	<input type="radio"/> Disable
IP Address	<input type="text" value="0"/> . <input type="text" value="0"/> . <input type="text" value="0"/> . <input type="text" value="0"/>	
Subnet Mask	<input type="text" value="0"/> . <input type="text" value="0"/> . <input type="text" value="0"/> . <input type="text" value="0"/>	

Choose not bridge to set the port's own properties, detailed properties are as below:

MTU: maximum transfer unit

Multicast forwarding: enable or disable multicast forwarding

Masquerade/NAT: enable or disable Masquerade/NAT

IP Address: set ra0's IP address, and do not conflict with other ports or bridge

Subnet Mask: set the port's subnet mask

Multiple DHCP Server

DHCP 0	ra0	On	Start	100	Max	50	Leasetime	3600
<input type="button" value="Delete"/>								
<input type="button" value="Add"/>								

Multiple DHCPD: using multiple DHCP service. Click 'Add' in multiple DHCP server to appear relevant configuration. The first means the name of port or bridge (do not be configured as eth0), the second means whether to on DHCP. Start means start address, Max means maximum assigned DHCP clients, Leasetime means the client lease time, the unit is second, click 'Save' or 'Apply' to put it into effect after setting.

Note: Only configure and click 'Save' can configure the next, can not configure multiple DHCP at the same time.

3.3.2 Wireless

3.3.2.1 Basic Settings

Wireless Physical Interface wl0 [2.4 GHz]

Wireless Network Enable Disable

Physical Interface ra0 - SSID [dd-junjinlee] HWAddr [00:AA:BB:CC:DD:15]

Wireless Mode AP ▼

Wireless Network Mode N-Only ▼

802.11n Transmission Mode Mixed ▼

Wireless Network Name (SSID) dd-junjinlee

Wireless Channel 11 - 2.462 GHz ▼

Channel Width 40 MHz ▼

Extension Channel upper ▼

Wireless SSID Broadcast Enable Disable

Network Configuration Unbridged Bridged

Virtual Interfaces

Add

Save
Apply Settings
Cancel Changes

Wireless Network: "Eanble", radio on. "Disable", radio off.

Wireless Mode: AP, Client, Adhoc, Repeater, Repeater Bridge four options.

Wireless Network Mode:

Mixed: Support 802.11b, 802.11g, 802.11n wireless devices.

BG-Mixed: Support 802.11b, 802.11g wireless devices.

B-only: Only supports the 802.11b standard wireless devices.

B-only: Only supports the 802.11b standard wireless devices.

G-only: Only supports the 802.11g standard wireless devices.

NG-Mixed: Support 802.11g, 802.11n wireless devices.

N-only: Only supports the 802.11g standard wireless devices.

802.11n Transmission Mode : In the wireless network mode to "N-only" choose to transfer its transmission mode.

Greenfield: When you determine the surrounding environment, there is no other 802.11a/b/g devices use the same channel, use this mode to increase throughput. Other

802.11a/b/g devices use the same channel in the environment, the information you send may generate an error, re-issued.

Mixed: This mode is contrary to the green mode, but will reduce the throughput.

Wireless Network Name(SSID): The SSID is the network name shared among all devices in a wireless network. The SSID must be identical for all devices in the wireless network. It is case-sensitive and must not exceed 32 alphanumeric characters, which may be any keyboard character. Make sure this setting is the same for all devices in your wireless network.

Wireless Channel : A total of 1-13 channels to choose more than one wireless device environment, please try to avoid using the same channel with other devices.

Channel Width: 20MHZ and 40MHZ.

Extension Channel: Channel for 40MHZ, you can choose upper or lower.

Wireless SSID Broadcast:

Enable: SSID broadcasting.

Disable: Hidden SSID.

Network Configuration:

Bridged: Bridge to the Router, under normal circumstances, please select the bridge.

Unbridged : There is no bridge to the Router, IP addresses need to manually configure.

Network Configuration	<input checked="" type="radio"/> Unbridged <input type="radio"/> Bridged
Multicast forwarding	<input type="radio"/> Enable <input checked="" type="radio"/> Disable
Masquerade / NAT	<input checked="" type="radio"/> Enable <input type="radio"/> Disable
IP Address	<input type="text" value="192"/> <input type="text" value="168"/> <input type="text" value="1"/> <input type="text" value="1"/>
Subnet Mask	<input type="text" value="255"/> <input type="text" value="255"/> <input type="text" value="0"/> <input type="text" value="0"/>

Virtual Interfaces : Click Add to add a virtual interface. Add successfully, click on the remove, you can remove the virtual interface.

Virtual Interfaces

Virtual Interfaces ra1 SSID [dd-wrt_vap] HWAddr [00:AA:BB:CC:DD:16]

Wireless Network Name (SSID)	<input type="text" value="dd-wrt_vap"/>
Wireless SSID Broadcast	<input checked="" type="radio"/> Enable <input type="radio"/> Disable
AP Isolation	<input type="radio"/> Enable <input checked="" type="radio"/> Disable
Network Configuration	<input type="radio"/> Unbridged <input checked="" type="radio"/> Bridged

AP Isolation: This setting isolates wireless clients so access to and from other wireless clients are stopped.

Note: Save your changes, after changing the "Wireless Mode", "Wireless Network Mode", "wireless width", "broadband" option, please click on this button, and then configure the other options.

3.3.2.2 Wireless Security

Wireless security options used to configure the security of your wireless network. This route is a total of seven kinds of wireless security mode. Disabled by default, not safe mode is enabled. Such as changes in Safe Mode, click Apply to take effect immediately.

Wireless Security wl0

Physical Interface ra0 SSID [dd-junjinlee] HWAddr [00:AA:BB:CC:DD:15]

Security Mode

Wireless Security w10

Physical Interface ra0 SSID [four-faith] HWAddr [00:0C:43:30:52:79]

Security Mode	<input type="text" value="WEP"/>
Authentication Type	<input checked="" type="radio"/> Open <input type="radio"/> Shared Key
Default Transmit Key	<input checked="" type="radio"/> 1 <input type="radio"/> 2 <input type="radio"/> 3 <input type="radio"/> 4
Encryption	<input type="text" value="64 bits 10 hex digits/5 ASCII"/>
ASCII/HEX	<input type="radio"/> ASCII <input checked="" type="radio"/> HEX
Passphrase	<input type="text" value="1111111111111111"/> <input type="button" value="Generate"/>
Key 1	<input type="text" value="2627F68597"/>
Key 2	<input type="text" value="15AD1DD294"/>
Key 3	<input type="text" value="DDC4761939"/>
Key 4	<input type="text" value="31F1ADB558"/>

WEP: Is a basic encryption algorithm is less secure than WPA. Use of WEP is discouraged due to security weaknesses, and one of the WPA modes should be used whenever possible. Only use WEP if you have clients that can only support WEP (usually older, 802.11b-only clients).

Authentication Type: Open or shared key.

Default Transmit Key: Select the key form Key 1 - Key 4 key.

Encryption: There are two levels of WEP encryption, 64-bit (40-bit) and 128-bit. To utilize WEP, select the desired encryption bit, and enter a passphrase or up to four WEP key in hexadecimal format. If you are using 64-bit (40-bit), then each key must consist of exactly 10 hexadecimal characters or 5 ASCII charceters. For 128-bit, each key must consist of exactly 26 hexadecimal characters. Valid hexadecimal characters are "0"- "9" and "A"- "F".

ASCII/HEX: ASCII, the keys is 5 bit ASCII characters/13bit ASCII characters.

HEX, the keys is 10bit/26 bit hex digits.

Passphrase: The letters and numbers used to generate a key.

Key1-Key4: Manually fill out or generated according to input the pass phrase.

Wireless Security w10

Physical Interface ra0 SSID [dd-junjinlee] HWAddr [00:AA:BB:CC:DD:15]

Security Mode: WPA Personal

WPA Algorithms: AES

WPA Shared Key: [masked] Unmask

Key Renewal Interval (in seconds): 3600 (Default: 3600, Range: 1 - 99999)

Save Apply Settings

WPA Personal/WPA2 Personal/WPA2 Person Mixed:, TKIP/AES/TKIP+AES, dynamic encryption keys. TKIP + AES, self-applicable TKIP or AES. WPA Person Mixed, allow WPA Personal and WPA2 Personal client mix.

WPA Shared Key: Between 8 and 63 ASCII character or hexadecimal digits.。

Key Renewal Interval (in seconds): 1-99999.。

Wireless Security w10

Physical Interface ra0 SSID [dd-junjinlee] HWAddr [00:AA:BB:CC:DD:15]

Security Mode: WPA Enterprise

WPA Algorithms: AES

Radius Auth Server Address: 192.168.1.110

Radius Auth Server Port: 1812 (Default: 1812)

Radius Auth Shared Secret: [masked] Unmask

Key Renewal Interval (in seconds): 3600

WPA Enterprise/WPA2 Enterprise/WPA2 Enterprise Mixed: WPA Enterprise uses an external RADIUS server to perform user authentication.

WPA Algorithms: AES/TKIP/TPIP+AES.

Radius Auth Sever Address: The IP address of the RADIUS server.

Radius Auth Server Port: The RADIUS Port (default is 1812)。

Radius Auth Shared Secret: The shared secret from the RADIUS server.。

Key Renewal Interva(in seconds): 1-99999

3.3.3 Services

3.3.3.1 Services

DHCP Server

DHCP assigns IP addresses to users local devices. While the main configuration is on the setup page users can program some nifty special functions here.

DHCP Server

Use JFFS2 for client lease DB *(Not mounted)*

Use NVRAM for client lease DB

Used Domain WAN ▼

LAN Domain

Additional DHCPd Options

Static Leases

MAC Address	Host Name	IP Address	Client Lease Time
<input style="width: 90%;" type="text"/>	<input style="width: 90%;" type="text"/>	<input style="width: 90%;" type="text"/>	<input style="width: 90%;" type="text"/> minutes

Use NVRAM for client lease DB: users can store data to the system NVRAM area is enabled

Used domain: users can select here which domain the DHCP clients should get as their local domain. This can be the WAN domain set on the Setup screen or the LAN domain which can be set here.

LAN Domain: users can define here their local LAN domain which is used as local domain for DNSmasq and DHCP service if chose above.

Static Leases: if users want to assign certain hosts a specific address then they can

define them here. This is also the way to add hosts with a fixed address to the Router's local DNS service (DNSmasq).

Additional DHCPd Options: some extra options users can set by entering them

DNSMasq

DNSmasq is a local DNS server. It will resolve all host names known to the Router from dhcp (dynamic and static) as well as forwarding and caching DNS entries from remote DNS servers. Local DNS enables DHCP clients on the LAN to resolve static and dynamic DHCP hostnames.

The screenshot shows a configuration window titled "DNSMasq". It contains the following options:

- DNSMasq:** Enable Disable
- Local DNS:** Enable Disable
- No DNS Rebind:** Enable Disable
- Additional DNSMasq Options:** A large empty text input field.

Local DNS: enables DHCP clients on the LAN to resolve static and dynamic DHCP hostnames

No DNS Rebind: when enabled, it can prevent an external attacker to access the Router's internal Web interface. It is a security measure

Additional DNSMasq Options: some extra options users can set by entering them in Additional DNS Options.

For example:

Static allocation:

`dhcp-host=AB:CD:EF:11:22:33,192.168.0.10,myhost,myhost.domain,12h`

max lease number: `dhcp-lease-max=2`

DHCP server IP range: `dhcp-range=192.168.0.110,192.168.0.111,12h`

SNMP



The screenshot shows the SNMP configuration page. At the top, there is a title 'SNMP' and a status section with 'Enable' (checked) and 'Disable' (unchecked) radio buttons. Below this are several input fields: 'Location' with the value 'Unknown', 'Contact' with 'root', 'Name' with 'ff', 'RO Community' with 'public', and 'RW Community' with 'private'.

Location: equipment location

Contact: contact this equipment management

Name: device name

RO Community: SNMP RO community name, the default is public, Only to read.

RW Community: SNMP RW community name, the default is private, Read-write permissions

SSHD

Enabling SSHd allows users to access the Linux OS of their Router with an SSH client

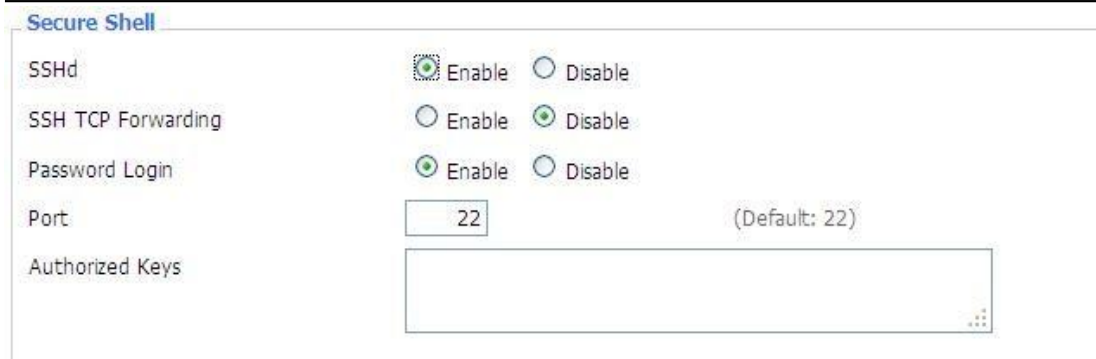

The screenshot shows the Secure Shell configuration page. It has a title 'Secure Shell' and several settings: 'SSHd' (checked), 'SSH TCP Forwarding' (unchecked), 'Password Login' (checked), and 'Port' (22, with '(Default: 22)' next to it). There is also an 'Authorized Keys' field which is currently empty.

SSH TCP Forwarding: enable or disable to support the TCP forwarding **Password Login:** allows login with the Router password (username is admin) **Port:** port number for SSHd (default is 22)

Authorized Keys: here users paste their public keys to enable key-based login (more secure than a simple password)

System log

Enable Syslogd to capture system messages. By default they will be collected in the local file /var/log/messages. To send them to another system, enter the IP address of a remote syslog server.

System Log

Syslogd Enable Disable

Syslog Out Mode Net Console

Remote Server

Syslog Out Mode: two log mode

Net: the log information output to a syslog server

Console: the log information output to console port

Remote Server: if choose net mode, users should input a syslog server's IP Address and run a syslog server program on it.

Telnet

Telnet

Telnet Enable Disable

Telnet: enable a telnet server to connect to the Router with telnet. The username is admin and the password is the Router's password.

Note: If users use the Router in an untrusted environment (for example as a public hotspot), it is strongly recommended to use SSHd and deactivate telnet.

WAN Traffic Counter

WAN Traffic Counter

ttraff Daemon Enable Disable

Ttraff Daemon: enable or disable wan traffic counter function

3.3.4 VPN

3.3.4.1 PPTP

PPTP Server

PPTP Server

PPTP Server Enable Disable

Broadcast support Enable Disable

Force MPPE Encryption Enable Disable

DNS1

DNS2

WINS1

WINS2

Server IP

Client IP(s)

CHAP-Secrets

Broadcast support: enable or disable broadcast support of PPTP server

Force MPPE Encryption: enable or disable force MPPE encryption of PPTP data

DNS1/DNS2/WINS1/WINS2: set DNS1/DNS2/WINS1/WINS2

Server IP: input IP address of the Router as PPTP server, differ from LAN address

Client IP(s): IP address assigns to the client, the format is xxx.xxx.xxx.xxx-xxx

CHAP Secrets: user name and password of the client using PPTP service

Note: client IP must be different with IP assigned by Router DHCP. The format of CHAP Secrets is user * password *.

PPTP Client

PPTP Client

PPTP Client Options Enable Disable

Server IP or DNS Name

Remote Subnet

Remote Subnet Mask

MPPE Encryption

MTU (Default: 1450)

MRU (Default: 1450)

NAT Enable Disable

User Name

Password Unmask

Remote Subnet Mask: subnet mask of remote PPTP server

MPPE Encryption: enable or disable Microsoft Point-to-Point Encryption.

MTU: maximum Transmission Unit

MRU: maximum Receive Unit

NAT: network Address Translation

User Name: user name to login PPTP Server.

Password: password to log into PPTP Server.

3.3.4.2 L2TP

L2TP Server

L2TP Server

L2TP Server Options Enable Disable

Force MPPE Encryption Enable Disable

Server IP

Client IP(s)

CHAP-Secrets

Force MPPE Encryption: enable or disable force MPPE encryption of L2TP data

Server IP: input IP address of the Router as PPTP server, differ from LAN address

Client IP(s): IP address assigns to the client, the format is

xxx.xxx.xxx.xxx-xxx.xxx.xxx.xxx

CHAP Secrets: user name and password of the client using L2TP service

Note: client IP must be different with IP assigned by Router DHCP.

L2TP Client

L2TP Client

L2TP Client Options Enable Disable

User Name

Password Unmask

Gateway (L2TP Server)

Remote Subnet

Remote Subnet Mask

MPPE Encryption

MTU (Default: 1450)

MRU (Default: 1450)

NAT Enable Disable

Require CHAP Yes No

Refuse PAP Yes No

Require Authentication Yes No

Gateway(L2TP Server): L2TP server’s IP Address or DNS Name

Remote Subnet: the network of remote PPTP server

Remote Subnet Mask: subnet mask of remote PPTP server

MPPE Encryption: enable or disable Microsoft Point-to-Point Encryption

MTU: maximum transmission unit

MRU: maximum receive unit

NAT: network address translation

User Name: user name to login L2TP Server

Password: password to login L2TP Server

Require CHAP: enable or disable support chap authentication protocol

Refuse PAP: enable or disable refuse to support the pap authentication

Require Authentication: enable or disable support authentication protocol

3.3.4.3 OPENVPN

OPENVPN Server

Start Type WAN Up System

Start Type: WAN UP----start after on-line, System----start when boot up

Config via GUI Config File
 Server mode Router (TUN) Bridge (TAP)

Config via: GUI----Page configuration, Config File----config File configuration

Server mode: Router (TUN)-route mode, Bridge (TAP)----bridge mode

Router (TUN):

Network
 Netmask

Network: network address allowed by OPENVPN server

Netmask: netmask allowed by OPENVPN server

Bridge (TAP):

DHCP-Proxy mode Enable Disable
 Pool start IP
 Pool end IP
 Gateway
 Netmask

DHCP-Proxy mode: enable or disable DHCP-Proxy mode

Pool start IP: pool start IP of the client allowed by OPENVPN server

Pool end IP: pool end IP of the client allowed by OPENVPN server

Gateway: the gateway of the client allowed by OPENVPN server

Netmask: netmask of the client allowed by OPENVPN server

Port	<input type="text" value="1194"/>	(Default: 1194)
Tunnel Protocol	<input type="text" value="UDP"/>	
Encryption Cipher	<input type="text" value="Blowfish CBC"/>	
Hash Algorithm	<input type="text" value="SHA1"/>	

Port: listen port of OPENVPN server

Tunnel Protocol: UCP or TCP of OPENVPN tunnel protocol

Encryption Cipher: Blowfish CBC , AES-128 CBC , AES-192 CBC , AES-256 CBC , AES-512 CBC

Hash Algorithm: Hash algorithm provides a method of quick access to data, including SHA1, SHA256, SHA512, MD5

Advanced Options

Advanced Options	<input checked="" type="radio"/> Enable	<input type="radio"/> Disable
Use LZO Compression	<input type="radio"/> Enable	<input checked="" type="radio"/> Disable
Redirect default Gateway	<input type="radio"/> Enable	<input checked="" type="radio"/> Disable
Allow Client to Client	<input checked="" type="radio"/> Enable	<input type="radio"/> Disable
Allow duplicate cn	<input type="radio"/> Enable	<input checked="" type="radio"/> Disable
TUN MTU Setting	<input type="text" value="1500"/>	(Default: 1500)
MSS-Fix/Fragment across the tunnel	<input type="text"/>	(Default: Disable)
TLS Cipher	<input type="text" value="Disable"/>	
Client connect script	<input type="text"/>	

Use LZO Compression: enable or disable use LZO compression for data transfer

Redirect default Gateway: enable or disable redirect default gateway

Allow Client to Client: enable or disable allow client to client

Allow duplicate cn: enable or disable allow duplicate cn

TUN MTU Setting: set the value of TUN MTU

TCP MSS: MSS of TCP data

TLS Cipher: TLS (Transport Layer Security) encryption standard supports AES-128 SHA and AES-256 SHA

Client connect script: define some client script by user self

CA Cert

CA Cert: CA certificate

Public Server Cert

Public Server Cert: server certificate

Private Server Key

DH PEM

Private Server Key: the key seted by the server

DH PEM: PEM of the server

Additional Config	<div style="border: 1px solid #ccc; height: 130px; width: 100%;"></div>
CCD-Dir DEFAULT file	<div style="border: 1px solid #ccc; height: 35px; width: 100%;"></div>
TLS Auth Key	<div style="border: 1px solid #ccc; height: 35px; width: 100%;"></div>
Certificate Revoke List	<div style="border: 1px solid #ccc; height: 35px; width: 100%;"></div>

Additional Config: additional configurations of the server

CCD-Dir DEFAULT file: other file approaches

TLS Auth Key: authority key of Transport Layer Security

Certificate Revoke List: configure some revoke certificates

OPENVPN Client

Server IP/Name	<input type="text" value="0.0.0.0"/>	
Port	<input type="text" value="1194"/>	(Default: 1194)
Tunnel Device	<input type="text" value="TUN"/>	
Tunnel Protocol	<input type="text" value="UDP"/>	
Encryption Cipher	<input type="text" value="Blowfish CBC"/>	
Hash Algorithm	<input type="text" value="SHA1"/>	
nsCertType verification	<input type="checkbox"/>	

Server IP/Name: IP address or domain name of OPENVPN server

Port: listen port of OPENVPN client

Tunnel Device: TUN----Router mode, TAP----Bridge mode

Tunnel Protocol: UDP and TCP protocol

Encryption Cipher: Blowfish CBC , AES-128 CBC , AES-192 CBC , AES-256 CBC , AES-512 CBC

Hash Algorithm: Hash algorithm provides a method of quick access to data, including SHA1, SHA256, SHA512, MD5

nsCertType verification: support ns certificate type

Advanced Options	<input checked="" type="radio"/> Enable	<input type="radio"/> Disable
Use LZO Compression	<input type="radio"/> Enable	<input checked="" type="radio"/> Disable
NAT	<input type="radio"/> Enable	<input checked="" type="radio"/> Disable
Bridge TAP to br0	<input type="radio"/> Enable	<input checked="" type="radio"/> Disable
Local IP Address	<input type="text"/>	
TUN MTU Setting	<input type="text" value="1500"/>	(Default: 1500)
MSS-Fix/Fragment across the tunnel	<input type="text"/>	(Default: Disable)
TLS Cipher	<input type="text" value="Disable"/>	
TLS Auth Key	<input type="text"/>	
Additional Config	<input type="text"/>	
Policy based Routing	<input type="text"/>	

Use LZO Compression: enable or disable use LZO compression for data transfer

NAT: enable or disable NAT through function

Bridge TAP to br0: enable or disable bridge TAP to br0

Local IP Address: set IP address of local OPENVPN client

TUN MTU Setting: set MTU value of the tunnel

TCP MSS: mss of TCP data

TLS Cipher: TLS (Transport Layer Security) encryption standard supports AES-128 SHA and AES-256 SHA

TLS Auth Key: authority key of Transport Layer Security

Additional Config: additional configurations of OPENVPN server

Policy based Routing: input some defined routing policy

CA Cert	<input type="text"/>
Public Client Cert	<input type="text"/>
Private Client Key	<input type="text"/>

CA Cert: CA certificate

Public Client Cert: client certificate

Private Client Key: client key

3.3.4.4 IPSEC

Connect Status and Control

Show IPSEC connection and status of current Router on IPSEC page.

Connection status and control				
Name	Type	Common Name	status	Action
<input type="button" value="Add"/>				

Name: the name of IPSEC connection

Type: The type and function of current IPSEC connection

Common name: local subnet, local address, opposite end address and opposite end subnet of current connection

Status: connection status: closed, negotiating, establish

Closed: this connection does not launch a connection request to opposite end

Negotiating: this connection launch a request to opposite end, is under negotiating, the connection has not been established yet.

Establish: the connection has been established, enabled to use this tunnel

Action: the action of this connection, current is to delete, edit, reconnect and enable

Delete: to delete the connection, also will delete IPSEC if IPSEC has set up

Edit: to edit the configure information of this connection, reload this connection to make the configuration effect after edit

Reconnect: this action will remove current tunnel, and re-launch tunnel establish request

Enable: when the connection is enable, it will launch tunnel establish request when the system reboot or reconnect, otherwise the connection will not do it

Add: to add a new IPSEC connection

Add IPSEC connection or edit IPSEC connection

Type: to choose IPSEC mode and relevant functions in this part, supports tunnel mode client, tunnel mode server and transfer mode currently

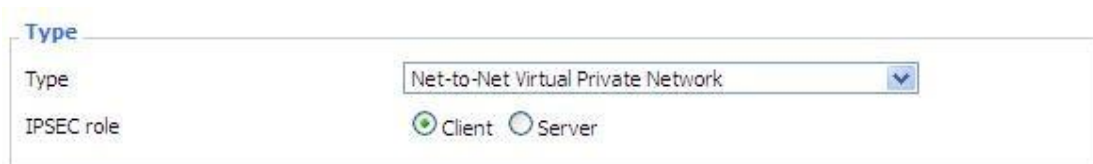

The screenshot shows a configuration window with a title bar labeled 'Type'. Inside the window, there are two main sections. The first section is labeled 'Type' and contains a dropdown menu currently displaying 'Net-to-Net Virtual Private Network'. The second section is labeled 'IPSEC role' and contains two radio buttons: 'Client' (which is selected, indicated by a green dot) and 'Server'.

Connection: this part contains basic address information of the tunnel

Connection			
Name	<input type="text"/>	Enabled	<input checked="" type="checkbox"/>
Local WAN Interface	vlan1 <input type="button" value="v"/>	Remote Host address	<input type="text"/>
Local Subnet	<input type="text"/>	Remote subnet	<input type="text"/>
Local Id	<input type="text"/>	Remote ID	<input type="text"/>

Name: to indicate this connection name, must be unique

Enabled: If enable, the connection will send tunnel connection request when it is reboot or re-connection, otherwise it is no need if disable

Local WAN Interface: local address of the tunnel

Remote Host Address: IP/domain name of end opposite; this option can not fill in if using tunnel mode server

Local Subnet: IPSec local protects subnet and subnet mask, i.e. 192.168.1.0/24; this option can not fill in if using transfer mode

Remote Subnet: IPSec opposite end protects subnet and subnet mask, i.e. 192.168.7.0/24; this option can not fill in if using transfer mode

Local ID: tunnel local end identification, IP and domain name are available

Remote ID: tunnel opposite end identification, IP and domain name are available

Detection: this part contains configure information of connection detection

Detection			
Enable DPD Detection	<input checked="" type="checkbox"/>		
Time Interval	<input type="text" value="60"/> (S)	Timeout	<input type="text" value="60"/> (S) Action <input type="button" value="hold"/> <input type="button" value="v"/>
Enable Connection Detection	<input checked="" type="checkbox"/>		

Enable DPD Detection: enable or disable this function, tick means enable

Time Interval: set time interval of connect detection (DPD)

Timeout: set the timeout of connect detection

Action: set the action of connect detection

Advanced Settings: this part contains relevant setting of IKE, ESP, negotiation mode, etc.

Advanced Settings

Enable advanced settings

IKE Encryption: 3DES IKE Integrity: MD5 IKE Groupype: MODP-8192

IKE Lifetime: 0 hours

ESP Encryption: 3DES ESP Integrity: MD5

ESP Keylife: 0 hours

IKE+ESP: Use only proposed settings.

IKE aggressive mode allowed. Avoid if possible (preshared key is transmitted in clear text)!

Perfect Forward Secrecy (PFS)

Negotiate payload compression

Enable Advanced Settings: enable to configure 1st and 2nd phase information, otherwise it will automic negotiation according to opposite end

IKE Encryption: IKE phased encryption mode

IKE Integrity: IKE phased integrity solution

IKE Groupype: DH exchange algorithm

IKE Lifetime: set IKE lifetime, current unit is hour, the default is 0

ESP Encryption: ESP encryption type

ESP Integrity: ESP integrity solution

ESP Keylife: set ESP keylife, current unit is hour, the default is 0

IKE aggressive mode allowed: negotiation mode adopt aggressive mode if tick; it is main mode if non-tick

Negotiate payload compression: Tick to enable PFS, non-tick to disable PFS

Authentication: choose use share encryption option or certificate authentication option. Current is only to choose use share encryption option.

Authentication

Use a Pre-Shared Key:

Generate and use the X.509 certificate

3.3.4.5 GRE

GRE (Generic Routing Encapsulation, Generic Routing Encapsulation) protocol is a network layer protocol (such as IP and IPX) data packets are encapsulated, so these encapsulated data packets to another network layer protocol (IP)transmission. GRE Tunnel (tunnel) technology, Layer Two Tunneling Protocol VPN (Virtual Private Network).

GRE Tunnel

GRE Tunnel Enable Disable

GRE Tunnel: enable or disable GRE function

Number	1 (fff) <input type="button" value="Delete"/>
Status	Enable <input type="button" value="v"/>
Name	fff <input type="text"/>
Through	PPP <input type="button" value="v"/>
Peer Wan IP Addr	120.42.46.98 <input type="text"/>
Peer Subnet	192.168.5.0/24 <input type="text"/> (eg:192.168.1.0/24)
Peer Tunnel IP	200.200.200.1 <input type="text"/>
Local Tunnel IP	200.200.200.5 <input type="text"/>
Local Netmask	255.255.255.0 <input type="text"/>

Number: Switch on/off GRE tunnel app

Status: Switch on/off someone GRE tunnel app

Name: GRE tunnel name

Through: The GRE packet transmit interface

Peer Wan IP Addr: The remote WAN address

Peer Subnet: The remote gateway local subnet, eg: 192.168.1.0/24

Peer Tunnel IP: The remote tunnel ip address

Local Tunnel IP: The local tunnel ip address

Local Netmask: Netmask of local network

Keepalive Enable Disable
 Retry times
 Interval
 Fail Action

Keepalive: Enable or disable GRE Keepalive function

Retry times: GRE keepalive detect fail retries

Interval: The time interval of GRE keepalive packet sent

Fail Action: The action would be exec after keeping alive failed.

Click on **“View GRE tunnels”** keys can view the information of GRE

GRE Tunnels list												
Number	Name	Enable	Through	Peer Wan IP Addr	Peer Subnet	Peer Tunnel IP	Local Tunnel IP	Local Netmask	Keepalive	Retry times	Interval	Fail Action
1	fff	Yes	PPP	120.42.46.98	192.168.5.0/24	200.200.200.1	200.200.200.5	255.255.255.0	No	0	0	Hold

3.3.5 Security

3.3.5.1 Firewall

You can enable or disable the firewall, filter specific Internet data types, and prevent anonymous Internet requests, ultimately enhance network security.

Firewall Protection

Firewall Protection
 SPI Firewall Enable Disable

Firewall enhance network security and use SPI to check the packets into the network. To use firewall protection, choose to enable otherwise disabled. Only enable the

SPI firewall, you can use other firewall functions: filtering proxy, block WAN requests, etc.

Additional Filters

Additional Filters

- Filter Proxy
- Filter Cookies
- Filter Java Applets
- Filter ActiveX

Filter Proxy: Wan proxy server may reduce the security of the gateway, Filtering Proxy will refuse any access to any wan proxy server. Click the check box to enable the function otherwise disabled.

Filter Cookies: Cookies are the website of data the data stored on your computer. When you interact with the site, the cookies will be used. Click the check box to enable the function otherwise disabled.

Filter Java Applets: If refuse to Java, you may not be able to open web pages using the Java programming. Click the check box to enable the function otherwise disabled.

Filter ActiveX: If refuse to ActiveX, you may not be able to open web pages using the ActiveX programming. Click the check box to enable the function otherwise disabled.

Prevent WAN Request

Block WAN Requests

- Block Anonymous WAN Requests (ping)
- Filter IDENT (Port 113)
- Block WAN SNMP access

Block Anonymous WAN Requests (ping): By selecting “Block Anonymous WAN Requests (ping)” box to enable this feature, you can prevent your network from the Ping or detection of other Internet users. so that make More difficult to break into your network. The default state of this feature is enabled, choose to disable allow anonymous Internet requests.

Filter IDENT (Port 113): Enable this feature can prevent port 113 from being scanned from outside. Click the check box to enable the function otherwise disabled.

Block WAN SNMP access: This feature prevents the SNMP connection requests from the WAN.

After Complete the changes, click the **Save Settings** button to save your changes. Click the **Cancel Changes** button to cancel unsaved changes.

Impede WAN DoS/Bruteforce

Impede WAN DoS/Bruteforce

Limit SSH Access

Limit Telnet Access

Limit PPTP Server Access

Limit L2TP Server Access

Limit ssh Access: This feature limits the access request from the WAN by ssh, and per minute up to accept two connection requests on the same IP. Any new access request will be automatically dropped.

Limit Telnet Access: This feature limits the access request from the WAN by Telnet, and per minute up to accept two connection requests on the same IP. Any new access request will be automatically dropped.

Limit PPTP Server Access: When build a PPTP Server in the Router, this feature limits the access request from the WAN by ssh, and per minute up to accept two connection requests on the same IP . Any new access request will be automatically dropped.

Limit L2TP Server Access: When build a L2TP Server in the Router, this feature limits the access request from the WAN by ssh, and per minute up to accept two connection requests on the same IP. Any new access request will be automatically dropped.

Log Management

The Router can keep logs of all incoming or outgoing traffic for your Internet connection.

Log

Log Enable Disable

Log: To keep activity logs, select Enable. To stop logging, select Disable. When select enable, the following page will appear.

Log

Log Enable Disable

Log Level

Options

Dropped

Rejected

Accepted

Log Level: Set this to the required log level. Set Log Level higher to log more actions.

Options: When select Enable, the corresponding connection will be recorded in the journal, the disabled are not recorded.

Incoming Log: To see a temporary log of the Router's most recent incoming traffic, click the Incoming Log button.

Incoming Log Table

Source IP	Protocol	Destination Port Number	Rule
-----------	----------	-------------------------	------

Outgoing Log: To see a temporary log of the Router's most recent outgoing traffic, click the Outgoing Log button.

Outgoing Log Table

LAN IP	Destination URL/IP	Protocol	Service/Port Number	Rule
192.168.1.164	223.203.188.56	TCP	www	Accepted
192.168.1.164	183.60.16.200	UDP	8000	Accepted
192.168.1.164	183.60.48.60	UDP	8000	Accepted
192.168.1.164	112.95.240.183	UDP	8000	Accepted
192.168.1.164	183.60.49.245	UDP	8000	Accepted
192.168.1.164	119.147.32.204	UDP	8000	Accepted
192.168.1.164	112.90.86.244	UDP	8000	Accepted
192.168.1.164	119.147.45.157	UDP	8000	Accepted
192.168.1.164	183.60.49.15	UDP	8000	Accepted
192.168.1.164	183.60.16.70	UDP	8000	Accepted
192.168.1.164	183.60.16.200	UDP	8000	Accepted
192.168.1.164	183.60.48.60	UDP	8000	Accepted

Click the **Save Settings** button to save your changes. Click the **Cancel Changes** button to cancel unsaved changes.

3.3.6 Access Restrictions

3.3.6.1 WAN Access

Use access restrictions, you can block or allow specific types of Internet applications.

You can set specific PC-based Internet access policies. This feature allows you to customize up to ten different Internet Access Policies for particular PCs, which are identified by their IP or MAC addresses.



Access Policy

Policy: 1 ()

Status: Enable Disable

Policy Name:

PCs:

Deny

Filter

Internet access during selected days and hours.

Two options in the default policy rules: "Filter" and "reject". If select "Deny", you will deny specific computers to access any Internet service at a particular time period. If you choose to "filter", It will block specific computers to access the specific sites at a specific time period. You can set up 10 Internet access policies filtering specific PCs access Internet services at a particular time period.

Access Policy: You may define up to 10 access policies. Click Delete to delete a policy or Summary to see a summary of the policy.

Status: Enable or disable a policy.

Policy Name: You may assign a name to your policy.

PCs: The part is used to edit client list, the strategy is only effective for the PC in the list.

Days

Everyday	Sun	Mon	Tue	Wed	Thu	Fri	Sat
<input checked="" type="checkbox"/>	<input type="checkbox"/>	<input type="checkbox"/>	<input type="checkbox"/>	<input type="checkbox"/>	<input type="checkbox"/>	<input type="checkbox"/>	<input type="checkbox"/>

Times

24 Hours

From 0:00 To 0:00

Days: Choose the day of the week you would like your policy to be applied.

Times: Enter the time of the day you would like your policy to be applied.

Website Blocking by URL Address

<input type="text"/>	<input type="text"/>	<input type="text"/>
<input type="text"/>	<input type="text"/>	<input type="text"/>
<input type="text"/>	<input type="text"/>	<input type="text"/>

Website Blocking by Keyword

<input type="text"/>	<input type="text"/>	<input type="text"/>	<input type="text"/>
<input type="text"/>	<input type="text"/>	<input type="text"/>	<input type="text"/>

Website Blocking by URL Address: You can block access to certain websites by entering their URL.

Website Blocking by Keyword: You can block access to certain website by the keywords contained in their webpage.

List of clients	
Enter MAC Address of the clients in this format: xx:xx:xx:xx:xx:xx	
MAC 01	00:AA:BB:CC:DD:EE
MAC 02	00:00:00:00:00:00
MAC 03	00:00:00:00:00:00
MAC 04	00:00:00:00:00:00
MAC 05	00:00:00:00:00:00
MAC 06	00:00:00:00:00:00
MAC 07	00:00:00:00:00:00
MAC 08	00:00:00:00:00:00
Enter the IP Address of the clients	
IP 01	192.168.1. 15
IP 02	192.168.1. 0
IP 03	192.168.1. 0
IP 04	192.168.1. 0
IP 05	192.168.1. 0
IP 06	192.168.1. 0
Enter the IP Range of the clients	
IP Range 01	192. 168. 1. 19 ~ 192 168 1 30
IP Range 02	0. 0. 0. 0 ~ 0 0 0 0

set up Internet access policy

1. Select the policy number (1-10) in the drop-down menu.
2. For this policy is enabled, click the radio button next to "Enable"
3. Enter a name in the Policy Name field.
4. Click the Edit List of PCs button.
5. On the List of PCs screen, specify PCs by IP address or MAC address. Enter the appropriate IP addresses into the IP fields. If you have a range of IP addresses to filter, complete the appropriate IP Range fields. Enter the appropriate MAC addresses into the MAC fields.
6. Click the Apply button to save your changes. Click the Cancel button to cancel your

unsaved changes. Click the Close button to return to the Filters screen.

7. If you want to block the listed PCs from Internet access during the designated days and time, then keep the default setting, Deny. If you want the listed PCs to have Internet filtered during the designated days and time, then click the radio button next to Filter.
8. Set the days when access will be filtered. Select Everyday or the appropriate days of the week.
9. Set the time when access will be filtered. Select 24 Hours, or check the box next to from and use the drop-down boxes to designate a specific time period.
10. Click the Add to Policy button to save your changes and active it.
11. To create or edit additional policies, repeat steps 1-9.
12. To delete an Internet Access Policy, select the policy number, and click the Delete button.

Note:

- 1) The default factory value of policy rules is "filtered". If the user chooses the default policy rules for "refuse", and editing strategies to save or directly to save the settings. If the strategy edited is the first, it will be automatically saved into the second, if not the first, keep the original number.
- 2) Turn off the power of the Router or reboot the Router can cause a temporary failure. After the failure of the Router, if can not automatically synchronized NTP time server, you need to recalibrate to ensure the correct implementation of the relevant period control function.

3.3.6.2 URL Filter

If you want to prevent certain client access to specific network domain name, such as www.sina.com. We can achieved it through the function of URL filter.

URL filtering function

Url Filter

Url Filter Setting

Enable Url Filter Enable Disable

Policy Discard packets conform to the following rules ▼

Del	Num	URL
<input type="checkbox"/>	1	WWW.SINA.COM

Add Filter Rule

Type URL ▼

Add

Discard packets conform to the following rules: only discard the matching URL address in the list.

Accept only the data packets conform to the following rules: receive only with custom rules of network address, discarded all other URL address.

3.3.6.3 Packet Filter

To block some packets getting Internet access or block some Internet packets getting local network access, you can configure filter items to block these packets.

Packet Filter

Packet filter function is realized based on IP address or port of packets.

Enable Packet Filter Enable Disable

Policy Discard packets conform to the following rules ▼

Enable Packet Filter: Enable or disable “packet filter” function

Policy: The filter rule’s policy, you can choose the following options

Discard the Following--Discard packets conform to the following rules, Accept all other packets

Only Accept the Following-- Accept only the data packets conform to the following rules, Discard all other packets

Add Filter Rule

Direction

Protocol

Source Ports -

Destination Ports -

Source IP . . . /

Destination IP . . . /

Direction

input: packet from WAN to LAN

output: packet from LAN to WAN

Protocol: packet protocol type

Source Ports: packet's source port

Destination Ports: packet's destination port

Source IP: packet's source IP address

Destination IP: packet's destination IP address

3.3.7 NAT**3.3.7.1 Port Forwarding**

Port Forwarding allows you to set up public services on your network, such as web servers, ftp servers, e-mail servers, or other specialized Internet applications. Specialized Internet applications are any applications that use Internet access to perform functions such as videoconferencing or online gaming. When users send this type of request to your network via the Internet, the Router will forward those requests to the appropriate PC.

Forwards

Application	Protocol	Source Net	Port from	IP Address	Port to	Enable
web	TCP	192.168.8.11	8000	192.168.1.12	80	<input checked="" type="checkbox"/>
ftp	Both	192.168.8.12	24	192.168.1.12	21	<input checked="" type="checkbox"/>

Application: Enter the name of the application in the field provided.

Protocol: Chose the right protocol TCP, UDP or Both. Set this to what the application requires.

Source Net: Forward only if sender matches this ip/net (example 192.168.1.0/24).

Port from: Enter the number of the external port (the port number seen by users on the Internet).

IP Address: Enter the IP Address of the PC running the application.

Port to: Enter the number of the internal port (the port number used by the application).

Enable: Click the Enable checkbox to enable port forwarding for the application.

Check all values and click **Save Settings** to save your settings. Click the **Cancel changes** button to cancel your unsaved changes.

3.3.7.2 Port Range Forward

Port Range Forwarding allows you to set up public services on your network, such as web servers, ftp servers, e-mail servers, or other specialized Internet applications. Specialized Internet applications are any applications that use Internet access to perform functions such as videoconferencing or online gaming. When users send this type of request to your network via the Internet, the Router will forward those requests to the appropriate PC.

Port Range Forward					
Forwards					
Application	Start	End	Protocol	IP Address	Enable
web-tftp	800	8100	Both	192.168.1.16	<input checked="" type="checkbox"/>
game	9000	10000	Both	192.168.1.16	<input checked="" type="checkbox"/>

Application: Enter the name of the application in the field provided.

Start: Enter the number of the first port of the range you want to be seen by users on the Internet and forwarded to your PC.

End: Enter the number of the last port of the range you want to be seen by users on the Internet and forwarded to your PC.

Protocol: Choose the right protocol TCP,UDP or Both. Set this to what the application requires.

IP Address: Enter the IP Address of the PC running the application.

Enable: Click the Enable checkbox to enable port forwarding for the application.

Check all values and click **Save Settings** to save your settings. Click the **Cancel changes** button to cancel your unsaved changes.

3.3.7.3 DMZ

The DMZ (De Militarized Zone) hosting feature allows one local user to be exposed to the Internet for use of a special-purpose service such as Internet gaming or videoconferencing. DMZ hosting forwards all the ports at the same time to one PC. The Port Forwarding feature is more secure because it only opens the ports you want to have opened, while DMZ hosting opens all the ports of one computer, exposing the computer so the Internet can see it.

Demilitarized Zone (DMZ)

DMZ

Use DMZ	<input checked="" type="radio"/> Enable <input type="radio"/> Disable
DMZ Host IP Address	192.168.8. <input type="text" value="166"/>

Any PC whose port is being forwarded must should have a new static IP address assigned to it because its IP address may change when using the DHCP function.

DMZ Host IP Address: To expose one PC to the Internet, select Enable and enter the computer's IP address in the DMZ Host IP Address field. To disable the DMZ, keep the default setting: Disable

Check all values and click **Save Settings** to save your settings. Click the **Cancel changes** button to cancel your unsaved changes.

3.3.8 QoS Setting

3.3.8.1 Basic

QoS allows control of the bandwidth allocation to different services, netmasks, MAC addresses and the four LAN ports.

Main WAN QoS Settings

Start QoS	<input type="radio"/> Enable <input checked="" type="radio"/> Disable
Port	<input type="text" value="WAN"/>
Packet Scheduler	<input type="text" value="HTB"/>
Uplink (kbps)	<input type="text" value="0"/>
Downlink (kbps)	<input type="text" value="0"/>

Bkup WAN QoS Settings

Start QoS	<input type="radio"/> Enable <input checked="" type="radio"/> Disable
Port	<input type="text" value="WAN"/>
Packet Scheduler	<input type="text" value="HTB"/>
Uplink (kbps)	<input type="text" value="0"/>
Downlink (kbps)	<input type="text" value="0"/>

Uplink (kbps): In order to use bandwidth management (QOS) you must enter bandwidth

values for your uplink. These are generally 80% to 90% of your maximum bandwidth.

Downlink (kbps) : In order to use bandwidth management (QOS) you must enter bandwidth values for your downlink. These are generally 80% to 90% of your maximum bandwidth.

3.3.8.2 Classify

Netmask Priority

Netmask Priority

Delete	IP/Mask	Priority
<input type="checkbox"/>	192.168.1.1/24	Exempt
<input type="checkbox"/>	192.168.2.3/24	Standard
<input type="checkbox"/>	192.168.3.4/32	Express
<input type="checkbox"/>	192.168.4.5/32	Bulk
	<input type="button" value="Add"/> <input type="text" value="0"/> . <input type="text" value="0"/> . <input type="text" value="0"/> . <input type="text" value="0"/> / <input type="text" value="0"/>	

You may specify priority for all traffic from a given IP address or IP Range.

Check all values and click **Save Settings** to save your settings. Click the **Cancel changes** button to cancel your unsaved changes.

3.3.9 Applications

3.3.9.1 Serial Application

This is for the console port on Router. Normally, this port is used to debug the Router. This port can also be used as a serial port. The Router has embedded a serial to TCP program. The data sent to the serial port is encapsulated by TCP/IP protocol stack and then is sent to the destination server. This function can work as a DTU (Data Terminal Unit).

Serial Applications

Serial Applications Enable Disable

Baudrate

Databit

Stopbit

Parity

Flow Control

Protocol

Server Address

Server Port

Device Number

Device Id

Heartbeat Interval

Baudrate: Baud rate indicates the number of bytes per second transported by device, commonly used baud rate is 115200, 57600, 38400, 19200.

Databit: the data bits can be 4, 5, 6, 7, 8, constitute a character. The ASCII code is usually used. Starting from the most significant bit is transmitted,.

Stopbit: it marks the end of a character data. It is a high level of 1, 1.5, 2.

Parity: use a set of data to check the data error

Flow control: including the hardware part and software part in two ways.

Enable Serial TCP Function: Enable the serial to TCP function

Protocol Type: The protocol type to transmit data.

UDP(DTU) – Data transmit with UDP protocol, work as a IP MODEM device which has application protocol and hear beat mechanism.

Pure UDP – Data transmit with standard UDP protocol.

TCP(DTU) -- Data transmit with TCP protocol, work as a IP MODEM device which has application protocol and hear beat mechanism.

Pure TCP -- Data transmit with standard TCP protocol, Router is the client.

TCP Server -- Data transmit with standard TCP protocol, Router is the server.

TCST -- Data transmit with TCP protocol, Using a custom data

Server Address: The data service center's IP Address or domain name.

Server Port: The data service center's listening port.

Device ID: The Router's identity ID.

Device Number: The Router's phone number.

Heartbeat Interval: The time interval to send heart beat packet. This item is valid only when you choose UDP(DTU) or TCP(DTU) protocol type.

TCP Server Listen Port: This item is valid when Protocol Type is "TCP Server"

Custom Heartbeat Packet: This item is valid when Protocol Type is "TCST"

Custom Registration Packets: This item is valid when Protocol Type is "TCST"

3.3.10 Administration

3.3.10.1 Management

The Management screen allows you to change the Router's settings. On this page you will find most of the configurable items of the Router code.

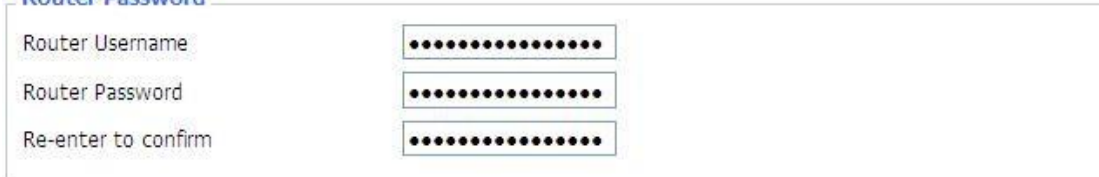

Router Password	
Router Username
Router Password
Re-enter to confirm

The new password must not exceed 32 characters in length and must not include any spaces. Enter the new password a second time to confirm it.

Note: Default username is admin. It is strongly recommended that you change the factory default password of the Router, which is admin. All users who try to access the Router's web-based utility or Setup Wizard will be prompted for the Router's password.

Web

Access

This feature allows you to manage the Router using either HTTP protocol or the HTTPS protocol. If you choose to disable this feature, a manual reboot will be required. You can also activate or not the Router information web page. It's now possible to password

protect this page (same username and password than above).

Web Access	
Protocol	<input checked="" type="checkbox"/> HTTP <input type="checkbox"/> HTTPS
Auto-Refresh (in seconds)	<input type="text" value="3"/>
Enable Info Site	<input checked="" type="radio"/> Enable <input type="radio"/> Disable
Info Site Password Protection	<input type="checkbox"/> Enabled

Protocol: This feature allows you to manage the Router using either HTTP protocol or the HTTPS protocol

Auto-Refresh : Adjusts the Web GUI automatic refresh interval. 0 disables this feature completely

Enable Info Site: Enable or disable the login system information page

Info Site Password Protection: Enable or disable the password protection feature of the system information page

Remote Access	
Web GUI Management	<input checked="" type="radio"/> Enable <input type="radio"/> Disable
Use HTTPS	<input type="checkbox"/>
Web GUI Port	<input type="text" value="8080"/> (Default: 8080, Range: 1 - 65535)
SSH Management	<input checked="" type="radio"/> Enable <input type="radio"/> Disable
SSH Remote Port	<input type="text" value="22"/> (Default: 22, Range: 1 - 65535)
Telnet Management	<input type="radio"/> Enable <input checked="" type="radio"/> Disable

Remote Access: This feature allows you to manage the Router from a remote location, via the Internet. To disable this feature, keep the default setting, Disable. To enable this feature, select Enable, and use the specified port (default is 8080) on your PC to remotely manage the Router. You must also change the Router's default password to one of your own, if you haven't already.

To remotely manage the Router, enter `http://xxx.xxx.xxx.xxx:8080` (the x's represent the Router's Internet IP address, and 8080 represents the specified port) in your web browser's address field. You will be asked for the Router's password.

If you use https you need to specify the url as `https://xxx.xxx.xxx.xxx:8080` (not all

firmwares does support this without rebuilding with SSL support).

SSH Management: You can also enable SSH to remotely access the Router by Secure Shell. Note that SSH daemon needs to be enable in Services page.

Note:

If the Remote Router Access feature is enabled, anyone who knows the Router's Internet IP address and password will be able to alter the Router's settings.

Telnet Management: Enable or disable remote Telnet function

Cron

Cron Enable Disable

Additional Cron Jobs

Cron: The cron subsystem schedules execution of Linux commands. You'll need to use the command line or startup scripts to actually use this.

Language Selection

Language

Language: Set up the Router page shows the type of language, including simplified Chinese and English.

Device Management

Device Management Enable Disable

Device Management Server IP

Device Management Server Listen Port (Default: 40001, Range: 1 - 65535)

Heart Interval (Default: 60Sec, Range: 1 - 999)

Device Number

Device Phone Number

Device Type Description

Remote Upgrade: custom-developed remote management server for this station Router monitoring and management, configuration parameters, WIFI advertising updates.

Remote Management Login Server

Remote Management Login Server	<input checked="" type="radio"/> Enable <input type="radio"/> Disable
Remote Login Server IP	<input type="text" value="192.168.8.57"/>
Remote Login Server Port	<input type="text" value="44008"/> (Default: 44008, Range: 1 - 65535)

Remote Management Login Server: In the case of more than one servers,the remote management login server is a general server.Connect the Router to this login server, the login server will assign an available server IP and port for the Router to connect for remote management.

Firmware Upgrade

Firmware Upgrade	<input checked="" type="radio"/> Enable <input type="radio"/> Disable
Upgrade Server IP	<input type="text" value="xmsx0618.f3322.org"/>
Upgrade Server Port	<input type="text" value="882"/> (Default: 882, Range: 1 - 65535)

Firmware Upgrade: custom-developed remote server for this station Router upgrading firmware.

3.3.10.2 Keep Alive

Schedule Boot&Shutdown

Schedule Boot&Shutdown

Schedule Boot&Shutdown	<input checked="" type="radio"/> Enable <input type="radio"/> Disable
Match	<input checked="" type="radio"/> Day <input type="radio"/> Weekday <input type="radio"/> Days <input type="radio"/> Weekdays
Shutdown Time	<input type="text" value="00"/> : <input type="text" value="00"/>
Shutdown Date	* <input type="text" value="01"/> Sunday <input type="text" value="Sunday"/>
Boot Time	<input type="text" value="00"/> : <input type="text" value="00"/>
Boot Date	* <input type="text" value="01"/> Sunday <input type="text" value="Sunday"/>

The user can set the startup or shutdown time:

For example,the user want to set the start time at 8:07 and boot time at 9:07.

Schedule Boot&Shutdown

Schedule Boot&Shutdown	<input checked="" type="radio"/> Enable <input type="radio"/> Disable
Match	<input checked="" type="radio"/> Day <input type="radio"/> Weekday <input type="radio"/> Days <input type="radio"/> Weekdays
Shutdown Time	08 : 07
Shutdown Date	* 01 Sunday Sunday
Boot Time	09 : 07
Boot Date	* 01 Sunday Sunday

Schedule Reboot

Schedule Reboot

Schedule Reboot	<input checked="" type="radio"/> Enable <input type="radio"/> Disable
Interval (in seconds)	<input checked="" type="radio"/> 3600
At a set Time	<input type="radio"/> 00 : 00 Sunday

You can schedule regular reboots for the Router: Regularly after xxx seconds. At a specific date time each week or everyday.

Note: For date based reboots Cron must be activated. See Management for Cron activation.

3.3.10.3 Commands

Commands: You are able to run command lines directly via the Webinterface.

Command Shell

Commands	<div style="border: 1px solid #ccc; height: 80px; width: 100%;"></div>
----------	--

Run Commands
Save Startup
Save Shutdown
Save Firewall

Save Custom Script

Run Command: You can run command lines via the web interface. Fill the text area with

your command and click Run Commands to submit.

Startup: You can save some command lines to be executed at startup's Router. Fill the text area with commands (only one command by row) and click Save Startup.

Shutdown: You can save some command lines to be executed at shutdown's Router. Fill the text area with commands (only one command by row) and click Save Shutdown.

Firewall Each time the firewall is started, it can run some custom iptables instructions. Fill the text area with firewall's instructions (only one command by row) and click Save Firewall.

Custom Script: Custom script is stored in /tmp/custom.sh file. You can run it manually or use cron to call it. Fill the text area with script's instructions (only one command by row) and click Save Custom Script.

3.3.10.4 Factory Defaults



Reset Router settings: Click the Yes button to reset all configuration settings to their default values. Then click the Apply Settings button.

Note:

Any settings you have saved will be lost when the default settings are restored.

After restoring the Router is accessible under the default IP address 192.168.1.1 and the default password admin.

3.3.10.5 Firmware Upgrade

Firmware Upgrade

After flashing, reset to

Please select a file to upgrade

Firmware Upgrade: New firmware versions are posted at www.yifanwireless.com and can be downloaded. If the Router is not experiencing difficulties, then there is no need to download a more recent firmware version, unless that version has a new feature that you want to use.

Note:

When you upgrade the Router's firmware, you lose its configuration settings, so make sure you write down the Router settings before you upgrade its firmware.

To upgrade the Router's firmware:

1. Download the firmware upgrade file from the website.
2. Click the Browse... button and chose the firmware upgrade file.
3. Click the Upgrade button and wait until the upgrade is finished.

Note:

Upgrading firmware may take a few minutes.

Do not turn off the power or press the reset button!

After flashing, reset to: If you want to reset the Router to the default settings for the firmware version you are upgrading to, click the Firmware Defaults option.

3.3.10.6 Backup

Backup Configuration

Backup Settings
Click the "Backup" button to download the configuration backup file to your computer.

Restore Configuration

Restore Settings
Please select a file to restore

WARNING

Only upload files backed up using this firmware and from the same model of router.
Do not upload any files that were not created by this interface!

Backup Settings: You may backup your current configuration in case you need to reset the Router back to its factory default settings. Click the Backup button to backup your current configuration.

Restore Settings : Click the Browse... button to browse for a configuration file that is currently saved on your PC. Click the Restore button to overwrite all current configurations with the ones in the configuration file.

Note:

Only restore configurations with files backed up using the same firmware and the same model of Router.

3.3.11 Status

3.3.11.1 Router

System

Router Name	Router
Router Model	Router
Firmware Version	v2.1.0 (Sep 8 2021 08:54:42) std - build 5829M
MAC Address	<u>54:D0:B4:26:05:85</u>
SN	FG5060178719
Host Name	
WAN Domain Name	
LAN Domain Name	
Current Time	Mon, 09 May 2022 11:09:21
Uptime	1:01

Router Name: name of the Router

Router Model: model of the Router, unavailable to modify

Firmware Version: software version information

MAC Address: MAC address of WAN, setting - Clone MAC Address to modify

Host Name: host name of the Router, setting - basic setting to modify

WAN Domain Name: domain name of WAN, setting - basic setting to modify

LAN Domain Name: domain name of LAN, unavailable to modify

Current Time: local time of the system

Uptime: operating uptime as long as the system is powered on

Memory

Total Available	125192 kB / 131072 kB	 96%
Free	94884 kB / 125192 kB	 76%
Used	30308 kB / 125192 kB	 24%
Buffers	3412 kB / 30308 kB	 11%
Cached	11936 kB / 30308 kB	 39%
Active	10528 kB / 30308 kB	 35%
Inactive	6512 kB / 30308 kB	 21%

Total Available: the room for total available of RAM (that is physical memory minus some reserve and the kernel of binary code bytes)

Free: free memory, the Router will reboot if the memory is less than 500kB

Used: used memory, total available memory minus free memory

Buffers: used memory for buffers,

Cached: the memory used by high-speed cache memory **Active:** active use of buffer or cache memory page file size **Inactive:** not often used in a buffer or cache memory page file size

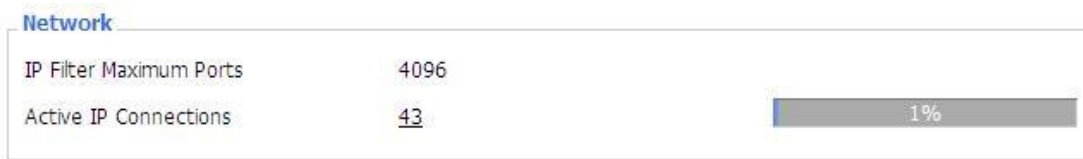

IP Filter Maximum Ports: preset is 4096, available to re-management

Active IP Connections: real time monitor active IP connections of the system, click to see the table as blow:

Active IP Connections 53

No.	Protocol	Timeout (s)	Source Address	Remote Address	Service Name	State
1	TCP	60	192.168.1.120	192.168.1.1		80 TIME_WAIT
2	TCP	30	192.168.1.120	192.168.1.1		80 TIME_WAIT
3	TCP	65	192.168.1.120	192.168.1.1		80 TIME_WAIT
4	TCP	96	192.168.1.120	192.168.1.1		80 TIME_WAIT
5	TCP	99	192.168.1.120	192.168.1.1		80 TIME_WAIT
6	TCP	70	192.168.1.120	192.168.1.1		80 TIME_WAIT
7	TCP	74	192.168.1.120	192.168.1.1		80 TIME_WAIT
8	TCP	115	192.168.1.120	192.168.1.1		80 TIME_WAIT
9	TCP	84	192.168.1.120	192.168.1.1		80 TIME_WAIT
10	TCP	3599	192.168.1.120	192.168.1.1		80 ESTABLISHED
11	TCP	3599	192.168.1.120	192.168.1.1		80 ESTABLISHED
12	TCP	108	192.168.1.120	192.168.1.1		80 TIME_WAIT
13	TCP	3600	192.168.1.120	192.168.1.1		80 ESTABLISHED
14	TCP	93	192.168.1.120	192.168.1.1		80 TIME_WAIT
15	TCP	102	192.168.1.120	192.168.1.1		80 TIME_WAIT
16	TCP	74	192.168.1.120	192.168.1.1		80 TIME_WAIT
17	TCP	3599	192.168.1.120	192.168.1.1		80 ESTABLISHED
18	TCP	15	192.168.1.120	192.168.1.1		80 TIME_WAIT
19	TCP	25	192.168.1.120	192.168.1.1		80 TIME_WAIT
20	TCP	90	192.168.1.120	192.168.1.1		80 TIME_WAIT
21	UDP	26	192.168.8.119	255.255.255.255	1947	UNREPLIED
22	TCP	77	192.168.1.120	192.168.1.1		80 TIME_WAIT
23	TCP	35	192.168.1.120	192.168.1.1		80 TIME_WAIT
24	TCP	74	192.168.1.120	192.168.1.1		80 TIME_WAIT
25	TCP	40	192.168.1.120	192.168.1.1		80 TIME_WAIT
26	TCP	3599	192.168.1.120	192.168.1.1		80 ESTABLISHED
27	TCP	74	192.168.1.120	192.168.1.1		80 TIME_WAIT
28	TCP	74	192.168.1.120	192.168.1.1		80 TIME_WAIT
29	TCP	4	192.168.1.120	192.168.1.1		80 TIME_WAIT
30	UDP	31	192.168.8.160	224.0.0.1	9166	UNREPLIED
31	TCP	74	192.168.1.120	192.168.1.1		80 TIME_WAIT

Active IP Connections: total active IP connections

Protocol: connection protocol

Timeouts: connection timeouts, unit is second

Source Address: source IP address

Remote Address: remote IP address

Service Name: connecting service port

Status: displayed status

3.3.11.2 WAN

Connection Type	Automatic Configuration - DHCP
Connection Uptime	Not available

Connection Type: disabled, static IP, automatic configuration-DHCP, PPPOE, PPTP, L2TP, 3G/UMTS

Connection Uptime: connecting uptime; If disconnect, display Not available

IP Address	0.0.0.0
Subnet Mask	0.0.0.0
Gateway	0.0.0.0
DNS 1	
DNS 2	
DNS 3	

IP Address: IP address of Router WAN **Subnet Mask:** subnet mask of Router WAN

Gateway: the gateway of Router WAN

DNS1, DNS2, DNS3: DNS1/DNS2/DNS3 of Router WAN

Remaining Lease Time	0 days 23:38:43
<input type="button" value="DHCP Release"/> <input type="button" value="DHCP Renew"/>	

Remaining Lease Time: remaining lease time of IP address in DHCP way

DHCP Release: release DHCP address

DHCP Renew: renew IP address in DHCP way, default is 1 day

Login Status

Disconnected

Connect

Login Status: connection status of WAN

Disconnection: disconnect

Connection: connect

Modem Model	NL668-AM-05
Band	LTE BAND 5
RSRP	50
RSRQ	26
	
Signal Status	-67 dBm
Network	FDD LTE

Module Model: built-in module model

Signal Status: signal intensity of the module in LTE network

Network: network type of the module in UMTS/LTE TDD/LTE FDD network



Total Flow: flow from power-off last time until now statistics, download and upload direction

Monthly Flow: the flow of a month, unit is MB

Last Month: the flow of last month

Next Month: the flow of next month



Backup: backup data administration **Restore:** restore data administration **Delete:** delete data administration

3.3.11.3 LAN

LAN Status

MAC Address	00:0C:43:30:52:77
IP Address	192.168.1.1
Subnet Mask	255.255.255.0
Gateway	0.0.0.0
Local DNS	0.0.0.0

MAC Address: MAC Address of the LAN port ethernet

IP Address: IP Address of the LAN port

Subnet Mask: Subnet Mask of the LAN port

Gateway: Gateway of the LAN port

Local DNS: DNS of the LAN port

Active Clients

Host Name	IP Address	MAC Address	Conn. Count	Ratio [4096]
*	192.168.1.120	10:78:D2:98:C9:46	57	1%

Host Name: host name of LAN client

IP Address: IP address of the client

MAC Address: MAC address of the client

Conn. Count: connection count caused by the client

Ratio: the ratio of 4096 connection

Dynamic Host Configuration Protocol

DHCP Status

DHCP Server	Enabled
DHCP Daemon	uDHCpd
Start IP Address	192.168.1.100
End IP Address	192.168.1.149
Client Lease Time	1440 minutes

DHCP Server: enable or disable the Router work as a DHCP server



DHCP Daemon: the agreement allocated using DHCP including DNSMasq and uDHCPd

Starting IP Address: the starting IP Address of the DHCP server's Address pool

Ending IP Address: the ending IP Address of the DHCP server's Address pool

Client Lease Time: the lease time of DHCP client

DHCP Clients

Host Name	IP Address	MAC Address	Client Lease Time	Delete
PC-201011161332	192.168.1.142	<u>00:21:5C:33:4D:29</u>	1 day 00:00:00	
jack-lincw	192.168.1.117	<u>44:37:E6:3F:45:54</u>	1 day 00:00:00	
*	192.168.1.149	<u>00:0C:E7:00:00:00</u>	1 day 00:00:00	

IP Address: IP address of the client

MAC Address: MAC address of the client

Expires: the expiry the client rents the IP address

Delete: click to delete DHCP client

Connected PPPOE Clients

Interface	User Name	Local IP	Delete
ppp0	hometest	192.168.10.10	

Interface: the interface assigned by dial-up system

User Name: user name of PPPOE client

Local IP: IP address assigned by PPPOE client

Delete: click to delete PPPOE client

Connected L2TP Server

Interface	Local IP	Remote IP	Delete
ppp0	172.168.8.2	172.168.8.1	

Interface: the interface assigned by dial-up system

Local IP: tunnel IP address of local L2TP

Remote IP: tunnel IP address of L2TP server

Delete: click to disconnect L2TP

Connected L2TP Clients

Interface	User Name	Local IP	Remote IP	Delete
ppp1	hometest	192.168.50.2	120.42.46.98	

Interface: the interface assigned by dial-up system

User Name: user name of the client

Local IP: tunnel IP address of L2TP client

Remote IP: IP address of L2TP client

Delete: click to delete L2TP client

Connected PPTP Server

Interface	Local IP	Remote IP	Delete
ppp0	172.168.8.2	172.168.8.1	

Interface: the interface assigned by dial-up system

Local IP: tunnel IP address of local PPTP

Remote IP: tunnel IP address of PPTP server

Delete: click to disconnect PPTP

Connected PPTP Clients

Interface	User Name	Local IP	Remote IP	Delete
ppp1	hometest	192.168.5.1	120.42.46.98	

Interface: the interface assigned by dial-up system

User Name: user name of the client

Local IP: tunnel IP address of PPTP client

Remote IP: IP address of PPTP client

Delete: click to delete PPTP client

3.3.11.4 Wireless

2.4G Wireless Status

MAC Address	<u>00:11:22:33:44:57</u>
Radio	Radio is On
Mode	AP
Network	Mixed
SSID	ssid
Channel	0 (2.437 GHz)
TX Power	20 dBm
Rate	96 Mb/s
Encryption - Interface w10	Disabled

MAC Address: MAC address of wireless client

Radio: display whether radio is on or not

Mode: wireless mode

Network: wireless network mode

SSID: wireless network name

Channel: wireless network channel

TX Power: reflection power of wireless network

Rate: reflection rate of wireless network

Encryption-Interface w10: enable or diasbal Encryption-Interface w10

PPTP Status: show wireless pptp status

Wireless Packet Info

Received (RX)	91125 OK, no error	100%
Transmitted (TX)	11957 OK, no error	100%

Received (RX): received data packet

Transmitted (TX): transmitted data packet

Wireless Nodes								
Clients								
MAC Address	Interface	Uptime	TX Rate	RX Rate	Signal	Noise	SNR	Signal Quality
- None -								

MAC Address: MAC address of wireless client

Interface: interface of wireless client

Uptime: connecting uptime of wireless client

TX Rate: transmit rate of wireless client

RX Rate: receive rate of wireless client

Signal: the signal of wireless client

Noise: the noise of wireless client

SNR: the signal to noise ratio of wireless client

Signal Quality: signal quality of wireless client

Neighbor's Wireless Networks										
SSID	Mode	MAC Address	Channel	Rssi	Noise	beacon	Open	dtim	Rate	Join Site
tzt-3g	Unknown	00:aa:bb:cc:dd:14	2	-5	-95	0	No	0	54(b/g)	Join
ff	Unknown	00:0c:43:30:52:79	6	-24	-95	0	No	0	300(b/g/n)	Join
ff-old	AP	00:13:10:09:56:92	6	-55	-95	0	No	0	54(b/g)	Join

Neighbor's Wireless Network: display other networks nearby

SSID: the name of wireless network nearby

Mode: operating mode of wireless network nearby

MAC Address: MAC address of the wireless nearby

Channel: the channel of the wireless nearby

Rssi: signal intensity of the wireless nearby

Noise: the noise of the wireless nearby

Beacon: signal beacon of the wireless nearby

Open: the wireless nearby is open or not

Dtim: delivery traffic indication message of the wireless nearby

Rate: speed rate of the wireless nearby

Join Site: click to join wireless network nearby

3.3.11.5 Bandwidth



Bandwidth Monitoring-LAN Graph

abscissa axis: time

vertical axis: speed rate

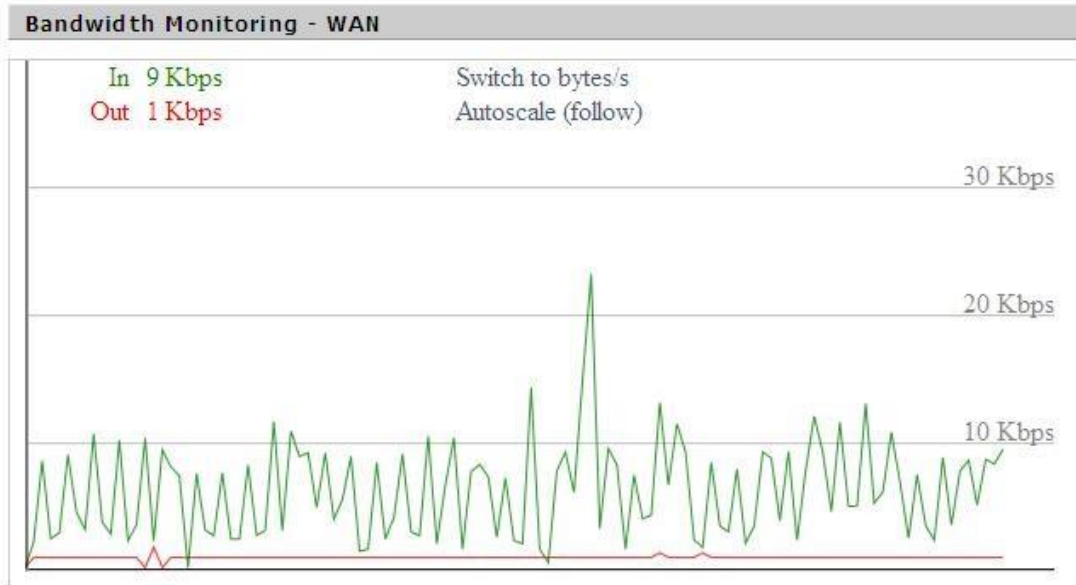

Bandwidth Monitoring-WAN Graph

abscissa axis: time

vertical axis: speed rate

3.3.11.6 System-Info

Router

Router Name	Router
Router Model	Router
LAN MAC	<u>54:D0:B4:26:05:84</u>
WAN MAC	<u>54:D0:B4:26:05:85</u>
Wireless MAC	<u>00:11:22:33:44:57</u>
WAN IP	10.77.212.64
BKUP WAN IP	0.0.0.0
LAN IP	192.168.1.1

Router Name: the name of the Router

Router Model: the model of the Router

LAN MAC: MAC address of LAN port

WAN MAC: MAC address of WAN port

Wireless MAC: MAC address of the wireless

WAN IP: IP address of WAN port

LAN IP: IP address of LAN port

Wireless

Radio	Radio is On
Mode	AP
Network	Mixed
SSID	ssid
Channel	0 (2.437 GHz)
TX Power	20 dBm
Rate	96 Mb/s

Radio: display whether radio is on or not

Mode: wireless mode

Network: wireless network mode

SSID: wireless network name

Channel: wireless network channel

TX Power: reflection power of wireless network

Rate: reflection rate of wireless network

Wireless Packet Info

Received (RX)	6982 OK, no error
Transmitted (TX)	1498 OK, no error

Received (RX): received data packet

Transmitted (TX): transmitted data packet

Wireless								
Clients								
MAC Address	Interface	Uptime	TX Rate	RX Rate	Signal	Noise	SNR	Signal Quality
- None -								

MAC Address: MAC address of wireless client

Interface: interface of wireless client

Uptime: connecting uptime of wireless client

TX Rate: transmit rate of wireless client

RX Rate: receive rate of wireless client

Signal: the signal of wireless client

Noise: the noise of wireless client

SNR: the signal to noise ratio of wireless client

Signal Quality: signal quality of wireless client

Services	
DHCP Server	Enabled
ff-radauth	Disabled
USB Support	Disabled

DHCP Server: enabled or disabled

ff-radauth: enabled or disabled

USB Support: enabled or disabled

Memory

Total Available	122.3 MB / 128.0 MB
Free	92.6 MB / 122.3 MB
Used	29.6 MB / 122.3 MB
Buffers	3.3 MB / 29.6 MB
Cached	11.7 MB / 29.6 MB
Active	10.3 MB / 29.6 MB
Inactive	6.4 MB / 29.6 MB

Total Available: the room for total available of RAM (that is physical memory minus some reserve and the kernel of binary code bytes)

Free: free memory, the Router will reboot if the memory is less than 500kB

Used: used memory, total available memory minus free memory

Buffers: used memory for buffers, total available memory minus allocated memory

Cached: the memory used by high-speed cache memory

Active: Active use of buffer or cache memory page file size

Inactive: Not often used in a buffer or cache memory page file size

DHCP			
DHCP Clients			
Host Name	IP Address	MAC Address	Expires
*	192.168.1.143	xx:xx:xx:xx:DD:45	1 day 00:00:00
four-488e1df5fa	192.168.1.125	xx:xx:xx:xx:D8:F7	1 day 00:00:00
Mycenae-PC	192.168.1.116	xx:xx:xx:xx:5E:30	1 day 00:00:00

Host Name: host name of LAN client

IP Address: IP address of the client

MAC Address: MAC address of the client

Expires: the expiry the client rents the IP address

Appendix

The following steps describe how to setup Windows XP Hyper Terminal.

1. Press "Start" "Programs" "Accessories" "Communications" "Hyper Terminal"

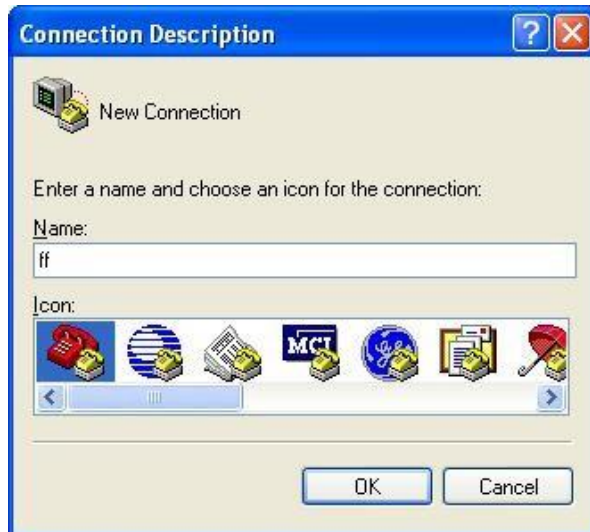

2. Input connection name, choose "OK"
3. Choose the correct COM port which connects to modem, choose "OK"



4. Configure the serial port parameters as following, choose "OK" Bits per second:
115200
Data bits: 8
Parity: None

Stop bits: 1

Flow control: None

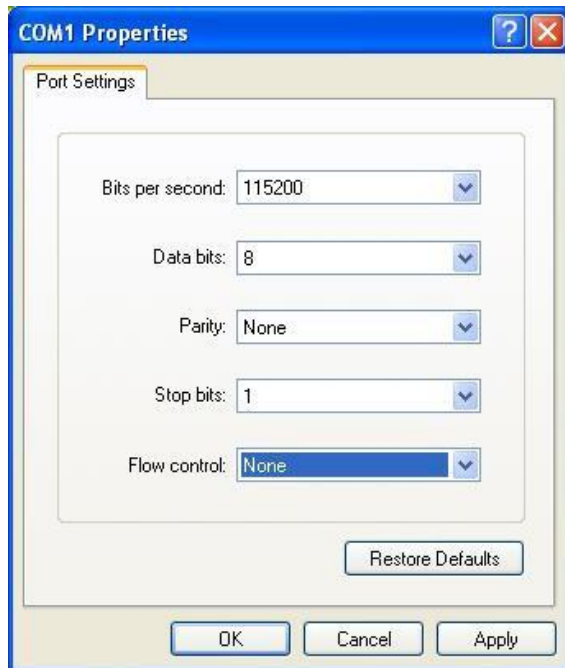

5. Complete Hyper Terminal operation, It runs as following

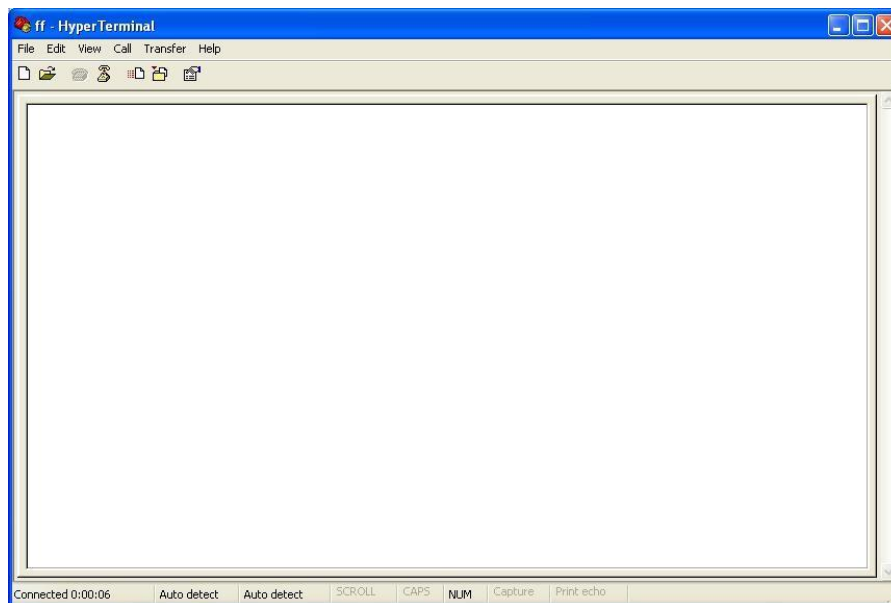

Note: If the user is using the win7 system, you can download a win7 super terminal on the internet. Universal serial interface or other similar software.